

Unknotting information from Heegaard Floer homology

Brendan Owens

Department of Mathematics, Louisiana State University, Baton Rouge, LA 70803

Abstract

We use Heegaard Floer homology to obtain bounds on unknotting numbers. This is a generalisation of Ozsváth and Szabó's obstruction to unknotting number one. We determine the unknotting numbers of 9_{10} , 9_{13} , 9_{35} , 9_{38} , 10_{53} , 10_{101} and 10_{120} ; this completes the table of unknotting numbers for prime knots with crossing number nine or less. Our obstruction uses a refined version of Montesinos' theorem which gives a Dehn surgery description of the branched double cover of a knot.

Key words: Unknotting number, Heegaard Floer homology.

1991 MSC: 57R58, 57M27

1 Introduction

Let K be a knot in S^3 . Given any diagram D for K , a new knot may be obtained by changing one or more crossings of D . The unknotting number $u(K)$ is the minimum number of crossing changes required to obtain the unknot, where the minimum is taken over all diagrams for K .

Let $\Sigma(K)$ denote the double cover of S^3 branched along K . A theorem of Montesinos ([10], or see Lemma 3.1) tells us that for any knot K , $\Sigma(K)$ is given by Dehn surgery on some framed link in S^3 with $u(K)$ components, with half-integral framing coefficients. This has proven very effective in finding obstructions to a knot having unknotting number one. If $u(K) = 1$ then $\Sigma(K)$ is obtained by $\pm(\det K)/2$ Dehn surgery on a knot C , where $\det K$ is the determinant of K . It follows that the linking pairing of $\Sigma(K)$ is determined up to sign by $\det K$ for an unknotting number one knot. Lickorish used this to show that the knot 7_4 has unknotting number 2 [8].

Email address: owens@math.lsu.edu (Brendan Owens).

Ozsváth and Szabó have shown in [17] that the Heegaard Floer homology of a 3-manifold Y gives an obstruction to Y being given by half-integral surgery on a knot in S^3 ; they apply this to $\Sigma(K)$ to obtain an obstruction to K having unknotting number one which generalises that of Lickorish. Combined with work of Gordon and Luecke [5] the Ozsváth-Szabó obstruction completes the classification of knots with unknotting number one and crossing number at most ten.

There is a basic difficulty in extending these obstructions to higher unknotting numbers. The double branched cover $\Sigma(K)$ is given by Dehn surgery on a link L with $u(K)$ components. One knows that the framing coefficients are half-integral, and knows the determinant of the linking matrix up to sign. When $u(K) = 1$ the linking matrix has one entry and so is equal to its determinant; moreover a one-by-one matrix is obviously definite (either positive or negative) which is a key ingredient in the Ozsváth-Szabó obstruction. In this paper we show that in certain circumstances, extra information involving the signature of the knot may be used to show that the linking matrix of L must belong to an easily-described finite list of positive-definite matrices. Using this we generalise the Ozsváth-Szabó obstruction to $u(K) = 1$ to arbitrary unknotting numbers.

Note that crossings in a knot diagram may be given a sign as in Figure 1 (independent of the choice of orientation of the knot). Let $\sigma(K)$ denote the signature of a knot K . It is shown in [3, Proposition 2.1] (also [18, Theorem 5.1]) that if K' is obtained from K by changing a positive crossing, then

$$\sigma(K') \in \{\sigma(K), \sigma(K) + 2\};$$

similarly if K' is obtained from K by changing a negative crossing then

$$\sigma(K') \in \{\sigma(K), \sigma(K) - 2\}.$$

Now suppose that K may be unknotted by changing p positive and n negative crossings (in some diagram). Since the unknot has zero signature, it follows that a bound for n is given by

$$n \geq \sigma(K)/2. \tag{1}$$

We will describe an obstruction to equality in (1). This is easiest to state for the case of an alternating knot; the obstruction is then a condition on the Goeritz matrix obtained from an alternating projection of K . (We will recall the definition of the Goeritz matrix in Section 4.) We also restrict for now to knots which can be unknotted with two crossing changes.

A positive-definite integral matrix Q of rank r presents a finite group Γ_Q via

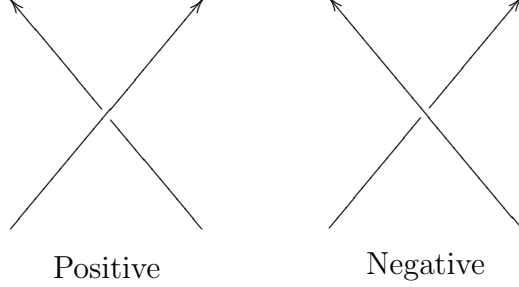

Fig. 1. **Signed crossings in a knot diagram.**

the short exact sequence

$$0 \longrightarrow \mathbb{Z}^r \xrightarrow{Q} \mathbb{Z}^r \longrightarrow \Gamma_Q \longrightarrow 0.$$

A *characteristic covector* for Q is an element of \mathbb{Z}^r which is congruent modulo 2 to the diagonal of Q , i.e., an element of

$$\text{Char}(Q) = \{\xi \in \mathbb{Z}^r \mid \xi_i \equiv Q_{ii} \pmod{2}\}.$$

Suppose that $\det Q$ is odd. Define a function

$$m_Q : \Gamma_Q \rightarrow \mathbb{Q}$$

by

$$m_Q(g) = \min \left\{ \frac{\xi^T Q^{-1} \xi - r}{4} \mid \xi \in \text{Char}(Q), [\xi] = g \right\}.$$

(The minimum exists since Q is positive-definite.)

Theorem 1 *Let K be an alternating knot which may be unknotted by changing p positive and n negative crossings, where $n = \sigma(K)/2$ and $p + n = 2$. Let G be the positive-definite Goeritz matrix obtained from an alternating diagram for K . Then there exists a positive-definite matrix*

$$\tilde{Q} = \begin{pmatrix} m_1 & 1 & a & 0 \\ 1 & 2 & 0 & 0 \\ a & 0 & m_2 & 1 \\ 0 & 0 & 1 & 2 \end{pmatrix},$$

with

$$\det \tilde{Q} = \det K,$$

$$0 \leq a < m_1 \leq m_2 \quad (\text{and hence } a < \det K/4),$$

and exactly n of $\{m_1, m_2\}$ are even; and a group isomorphism

$$\phi : \Gamma_{\tilde{Q}} \rightarrow \Gamma_G$$

with

$$m_{\tilde{Q}}(g) \geq m_G(\phi(g)),$$

and $m_{\tilde{Q}}(g) \equiv m_G(\phi(g)) \pmod{2}$

for all $g \in \Gamma_{\tilde{Q}}$.

Applying Theorem 1 to the alternating knots which were listed in [1] as having unknotting number 2 or 3 yields the following:

Corollary 2 *The knots $9_{10}, 9_{13}, 9_{35}, 9_{38}, 10_{53}, 10_{101}, 10_{120}$ have unknotting number 3.*

For all but one of the knots in Corollary 2, the signature is 4 and the unknotting number computation follows directly from Theorem 1. The exception is 9_{35} , whose signature is 2. The computation of $u(9_{35})$ uses Theorem 1 and also a result of Traczyk [19].

Corollary 2 completes the table of unknotting numbers for prime knots with 9 crossings or less.

Recall that for an oriented framed link C_1, \dots, C_r in S^3 , the linking matrix is the symmetric matrix (a_{ij}) with each diagonal entry a_{ii} given by the framing on C_i , and off-diagonal entries a_{ij} given by the linking numbers $\text{lk}(C_i, C_j)$. The following theorem is the key advance in this paper. It is a refinement of Montesinos' theorem, and was inspired by a theorem of Cochran and Lickorish [3, Theorem 3.7].

Theorem 3 *Suppose that a knot K may be unknotted by changing p positive and n negative crossings, with $n = \sigma(K)/2$. Then the branched double cover $\Sigma(K)$ may be obtained by Dehn surgery on an oriented, framed $p+n$ component link C_1, \dots, C_{p+n} in S^3 with linking matrix $\frac{1}{2}Q$, where Q is a positive-definite integral matrix which is congruent to the identity modulo 2, and exactly n of the diagonal entries of Q are congruent to 3 modulo 4.*

Moreover, by handlesliding, changing orientations, and re-ordering the link components one may replace the linking matrix with $\frac{1}{2}PQP^T$, for any $P \in GL(p+n, \mathbb{Z})$ which is congruent to a permutation matrix modulo 2. This preserves the number of diagonal entries congruent to 3 modulo 4.

It is shown in [13] that the double branched cover of the Montesinos knot 10_{145} does not bound any positive-definite four-manifold. This knot has signature two. Combining this with Theorem 3 (or the above-mentioned theorem of Cochran and Lickorish) yields the following:

Corollary 4 *If 10_{145} is unknotted by changing p positive crossings and n negative crossings, then $n \geq 2$.*

Given a matrix Q in $M(r, \mathbb{Z})$ which is conjugate modulo 2 to the identity, associate a matrix $\tilde{Q} \in M(2r, \mathbb{Z})$ by replacing each entry by a 2×2 -block as follows:

$$\begin{aligned} \text{odd entries:} \quad 2m - 1 &\mapsto \begin{bmatrix} m & 1 \\ 1 & 2 \end{bmatrix} \\ \text{even entries:} \quad 2a &\mapsto \begin{bmatrix} a & 0 \\ 0 & 0 \end{bmatrix}. \end{aligned} \tag{2}$$

Thus for example if $r = 2$,

$$Q = \begin{pmatrix} 2m_1 - 1 & 2a \\ 2a & 2m_2 - 1 \end{pmatrix} \mapsto \tilde{Q} = \begin{pmatrix} m_1 & 1 & a & 0 \\ 1 & 2 & 0 & 0 \\ a & 0 & m_2 & 1 \\ 0 & 0 & 1 & 2 \end{pmatrix}.$$

For a rational homology three-sphere Y , the *correction terms* of Ozsváth and Szabó are a set of rational numbers $\{d(Y, \mathfrak{s}) \mid \mathfrak{s} \in \text{Spin}^c(Y)\}$ which provide constraints on which four-manifolds Y may bound. We recall these constraints in Section 4; combining these with Theorem 3 yields the following unknotting obstruction, of which Theorem 1 is a special case.

Theorem 5 *Let K be a knot in S^3 which may be unknotted by changing p positive and n negative crossings, where $n = \sigma(K)/2$. Let Q_1, \dots, Q_k be a complete set of representatives of the finite quotient*

$$\frac{\{Q \in M(p+n, \mathbb{Z}) \mid Q \text{ is positive-definite, } \det Q = \det K, Q \equiv I \pmod{2}\}}{\{P \in GL(p+n, \mathbb{Z}) \mid P \text{ is congruent modulo 2 to a permutation matrix}\}}$$

with action given by $P \cdot Q = PQP^T$, and let $\tilde{Q}_1, \dots, \tilde{Q}_k$ be the corresponding elements of $M(2(p+n), \mathbb{Z})$. Then for some Q_i which has exactly n diagonal entries conjugate to 3 modulo 4, there exists a group isomorphism

$$\phi : \Gamma_{\tilde{Q}_i} \rightarrow \text{Spin}^c(\Sigma(K))$$

with

$$m_{\tilde{Q}_i}(g) \geq d(\Sigma(K), \phi(g)),$$

and $m_{\tilde{Q}_i}(g) \equiv d(\Sigma(K), \phi(g)) \pmod{2}$

for all $g \in \Gamma_{\tilde{Q}_i}$.

The following example illustrates the use of Theorem 5 to obstruct higher unknotting numbers.

Corollary 6 *The 11-crossing two-bridge knot $S(51, 35)$ (Dowker-Thistlethwaite name 11a365) has unknotting number 4.*

Organisation. In Section 2 we establish some results in Kirby-Rolfsen calculus which are needed for the proof of Theorem 3, which is given in Section 3. In Section 4 we recall some results of Ozsváth and Szabó in Heegaard Floer theory. Section 5 contains the proofs of Theorems 1 and 5. Finally in Section 6 we apply these theorems to examples and prove Corollaries 2 and 6.

Acknowledgements. The problem of generalising the obstruction in [17] to higher unknotting numbers was suggested to me by Peter Ozsváth. I am grateful to Peter Ozsváth, Ravi Ramakrishna, and Sašo Strle for helpful discussions and to the referee for helpful comments. Some Maple programs used in verifying Corollaries 2 and 6 were written jointly with Sašo Strle.

2 Kirby-Rolfsen calculus

In this section we establish some preliminaries on Dehn surgery. For details on Dehn surgery and Kirby-Rolfsen calculus see [6].

A framed link L in S^3 with rational framing coefficients determines a three-manifold Y_L by Dehn surgery (remove a tubular neighbourhood of each component of L ; the framing coefficient determines the gluing map to sew back a solid torus along the boundary). If the framing coefficients are integers one obtains a four-manifold W_L with boundary Y_L by attaching two-handles to B^4 along the components of L . Kirby-Rolfsen calculus describes when two framed links L, L' determine the same three-manifold Y_L .

Given a framed oriented link L with components C_1, \dots, C_m , let A denote the free abelian group with generators c_1, \dots, c_m . Define a symmetric bilinear form

$$Q : A \times A \rightarrow \mathbb{Q}$$

by

$$Q(c_i, c_j) = \begin{cases} \text{framing coefficient of } C_i & \text{if } i = j; \\ \text{linking number } \text{lk}(C_i, C_j) & \text{if } i \neq j. \end{cases}$$

In other words, the matrix of Q in the basis c_1, \dots, c_m is the linking matrix of L . (This is the intersection pairing on $H_2(W_L; \mathbb{Z})$ if the diagonal entries are integers.)

In the case that the framing coefficients on L are integers, any change of basis in A may be realised by a change in the link L . In particular the change of basis $c_i \mapsto c_i \pm c_j$ may be realised by a *handleslide*. Let λ_j denote a pushoff of C_j whose linking number with C_j equals the framing of C_j . A handleslide $C_i \mapsto C_i \pm C_j$ consists of replacing C_i by the oriented band sum of C_i with $\pm \lambda_j$. This gives a new link L' whose linking matrix is the matrix of Q in the basis $c_1, \dots, c'_i = c_i \pm c_j, \dots, c_m$ and with $Y_{L'} \cong Y_L$, $W_{L'} \cong W_L$. It will be convenient to have the following generalisation of handlesliding to links with rational framings.

Proposition 2.1 *Let L be an oriented link in S^3 consisting of components C_1, \dots, C_m with framings $\frac{p_1}{q_1}, \dots, \frac{p_m}{q_m}$, and let Q be the rational-valued bilinear pairing determined by the linking matrix of L . Then by replacing C_i in L it is possible to obtain a link L' whose linking matrix is the matrix of Q in the basis $c_1, \dots, c'_i = c_i \pm q_j c_j, \dots, c_m$ and with $Y_{L'} \cong Y_L$.*

Proof. For each $j = 1, \dots, m$ choose a continued fraction expansion

$$\frac{p_j}{q_j} = a_{l_j}^j - \frac{1}{a_{l_j-1}^j - \dots - \frac{1}{a_1^j}}.$$

(The numbers $a_{l_j}^j, \dots, a_1^j$ arise from the Euclidean algorithm as follows:

$$\begin{aligned} r_{l_j} &= p_j = a_{l_j}^j q_j - r_{l_j-2} \\ r_{l_j-1} &= q_j = a_{l_j-1}^j r_{l_j-2} - r_{l_j-3} \\ &\vdots \\ r_2 &= a_2^j r_1 - 1 \\ r_1 &= a_1^j. \end{aligned} \tag{3}$$

There is a standard procedure to obtain an integral surgery description of Y_L : as shown in Figure 2, we add a chain of linked unknots linking each C_j , with framings $a_1^j, \dots, a_{l_j-1}^j$, and replace the framing on C_j with $a_{l_j}^j$. (See e.g. [6,

§5.3].) Denote the resulting link by $L_{\mathbb{Z}}$, and let $Q_{\mathbb{Z}} : A_{\mathbb{Z}} \times A_{\mathbb{Z}} \rightarrow \mathbb{Z}$ denote the resulting bilinear form.

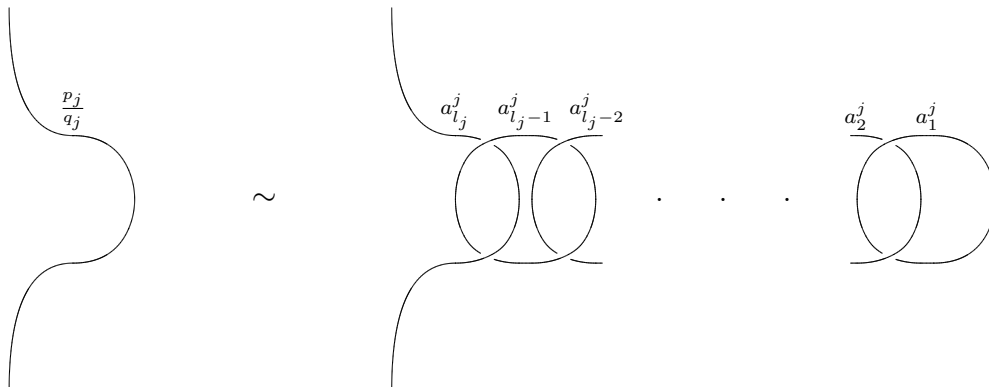

Fig. 2. **Converting between Dehn surgery and integral surgery.**

We now perform handleslides on this integer-framed link. Let U_1, \dots, U_{l_j-1} be the chain of unknots linking C_j as above, oriented so that $\text{lk}(C_j, U_{l_j-1}) = \text{lk}(U_k, U_{k-1}) = -1$, for $2 \leq k < l_j$. Let $K_1 = C_i + U_1$, and note that

$$\begin{aligned} \text{lk}(K_1, U_1) &= a_1^j, \\ \text{lk}(K_1, U_2) &= -1. \end{aligned} \tag{4}$$

We now define K_k recursively for $2 \leq k < l_j$. Choose any link diagram of $K_{k-1} \cup U_{k-1} \cup U_k$. By performing a handleslide over U_k for each crossing where K_{k-1} crosses over U_{k-1} we obtain a knot K_k which does not cross over U_{k-1} and therefore is separated from it by a two-sphere in S^3 (see Figure 3). The signed count of these handleslides is equal to the linking number of K_{k-1} and U_{k-1} ; thus we write

$$[K_k] = [K_{k-1}] + \text{lk}(K_{k-1}, U_{k-1})[U_k],$$

where $[K_k]$ denotes the element of $A_{\mathbb{Z}}$ corresponding to the knot K_k . We may use this to compute linking numbers and the framing of K_k . In particular

$$\text{lk}(K_2, U_2) = -1 + a_2^j \text{lk}(K_1, U_1), \tag{5}$$

and for $2 < k < l_j$,

$$\begin{aligned} \text{lk}(K_k, U_k) &= \text{lk}(K_{k-1}, U_k) + a_k^j \text{lk}(K_{k-1}, U_{k-1}) \\ &= -\text{lk}(K_{k-2}, U_{k-2}) + a_k^j \text{lk}(K_{k-1}, U_{k-1}). \end{aligned} \tag{6}$$

Finally we let C'_i be obtained as above from K_{l_j-1} by sliding over C_j , with C'_i unlinked from each of U_1, \dots, U_{l_j-1} . We then have

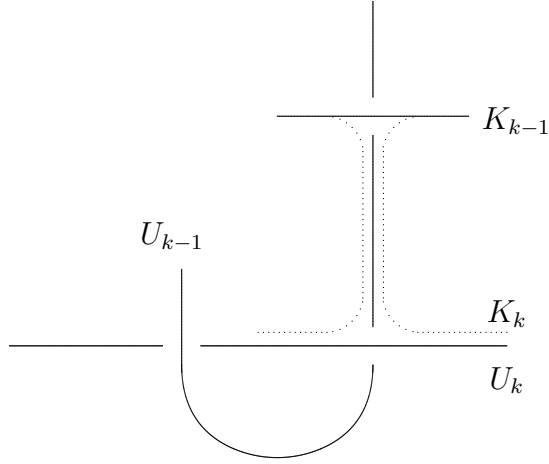

Fig. 3. **Handlesliding K_{k-1} over U_k yields K_k which is separated from U_{k-1} by a two-sphere.**

$$\begin{aligned} [C'_i] &= [K_{l_j-1}] + \text{lk}(K_{l_j-1}, U_{l_j-1})[C_j], \\ \text{lk}(C'_i, C_j) &= -\text{lk}(K_{l_j-2}, U_{l_j-2}) + a_{l_j}^j \text{lk}(K_{l_j-1}, U_{l_j-1}) + \text{lk}(C_i, C_j). \end{aligned} \quad (7)$$

Comparing (4), (5), (6), and (7) to (3) we see that

$$\begin{aligned} \text{lk}(K_k, U_k) &= r_k^j \quad \text{for } k = 1, \dots, l_j - 2, \\ \text{lk}(K_{l_j-1}, U_{l_j-1}) &= r_{l_j-1}^j = q_j, \\ \text{lk}(C'_i, C_j) &= p_j + \text{lk}(C_i, C_j). \end{aligned}$$

This yields

$$[C'_i] = [C_i] + \mathcal{U} + q_j[C_j],$$

where

$$\mathcal{U} = [U_1] + \sum_{k=2}^{l_j-1} r_{k-1} [U_k].$$

Note that by construction C'_i is separated by a two-sphere from each U_k and so $Q_{\mathbb{Z}}([C'_i], \mathcal{U}) = 0$. The framing of C'_i is given by

$$\begin{aligned}
Q_{\mathbb{Z}}([C'_i], [C'_i]) &= Q_{\mathbb{Z}}([C_i] + \mathcal{U} + q_j[C_j], [C_i] + \mathcal{U} + q_j[C_j]) \\
&= Q_{\mathbb{Z}}([C_i] + q_j[C_j], [C_i] + \mathcal{U} + q_j[C_j]) \\
&= Q_{\mathbb{Z}}([C_i], [C_i]) + 2q_j Q_{\mathbb{Z}}([C_i], [C_j]) + q_j^2 a_{i_j}^j - q_j r_{i_j-2} \\
&= a_{i_j}^j + 2q_j \text{lk}(C_i, C_j) + p_j q_j.
\end{aligned}$$

Converting from integer surgery to Dehn surgery (removing the chains of linking unknots from each of $C_1, \dots, C'_i, \dots, C_m$, as in Figure 2) gives the required link L' for the basis change $c'_i = c_i + q_j c_j$. To get the opposite sign construct C'_i as above but start with $K_1 = C_i - U_1$. \square

The following lemma is an application of the standard procedure, referred to in the proof of Proposion 2.1 and illustrated in Figure 2, for converting a Dehn surgery description of a three-manifold to an integral surgery description.

Lemma 2.2 *Let $L = \{C_1, \dots, C_r\}$ be a framed link in S^3 with framing $(2m_i - 1)/2$ on C_i , and let Y be the three-manifold obtained by Dehn surgery on L . Then Y is equal to the boundary of the four-manifold W obtained by adding 2-handles to B^4 along either of the following $2n$ -component framed links (as in Figure 4):*

- (i) *the link consisting of the components C_i with framing m_i plus a small linking unknot with framing 2, for each $i = 1, \dots, r$;*
- (ii) *the link consisting of C_i with framing m_i , plus a longitude C'_i with framing m_i and with the opposite orientation, with linking number $\text{lk}(C_i, C'_i) = 1 - m_i$, for each $i = 1, \dots, r$.*

Proof. The fact that Y is the boundary of the four-manifold given by the framed link (i) follows from the continued fraction expansions $(2m_i - 1)/2 = m_i - \frac{1}{2}$. The equivalence between (i) and (ii) follows by handlesliding: add C_i to C'_i to go from (ii) to (i). \square

Recall that to each matrix $Q \in M(r, \mathbb{Z})$ which is congruent to the identity modulo 2, we associate the matrix $\tilde{Q} \in M(2r, \mathbb{Z})$ as in (2). If a 3-manifold Y is given by Dehn surgery on a link with linking matrix $\frac{1}{2}Q$, then by Lemma 2.2, Y is the boundary of a simply-connected four-manifold with intersection pairing \tilde{Q} . Also note that $\det Q = \det \tilde{Q}$, and Q is positive-definite if and only if \tilde{Q} is positive-definite: let

$$\Delta_k(Q) = \det(Q_{ij})_{i,j \leq k}.$$

Then

$$\begin{aligned}\Delta_{2k}(\tilde{Q}) &= \Delta_k(Q), \\ \Delta_{2k-1}(\tilde{Q}) &= (\Delta_{2k-2}(\tilde{Q}) + \Delta_{2k}(\tilde{Q}))/2.\end{aligned}$$

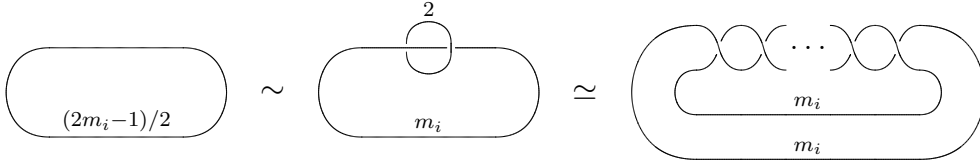

Fig. 4. **Half-integer surgery.** There are $2m_i - 2$ crossings in the diagram on the right.

3 Proof of Theorem 3

The proof of Theorem 3 consists of three lemmas. The first of these is a proof of Montesinos’ theorem using Kirby calculus. We could omit this and simply refer to proofs in the literature, for example [8] (or to the proof of Lemma 3.2). We include the proof since the four-dimensional point of view initially led us to a proof of Theorem 3, and since it spells out a useful algorithm for drawing a surgery diagram of $\Sigma(K)$. (For more details on Kirby diagrams of cyclic branched covers see [6, §6.3]; indeed what follows is a variation of the method in their Exercise 6.3.5(c).)

Lemma 3.1 *Let K be a knot in S^3 which can be unknotted by changing r crossings in some diagram D . Then the double branched cover $\Sigma(K)$ is given by Dehn surgery on an r -component link in S^3 with linking matrix $\frac{1}{2}Q$, where Q is congruent to the identity modulo 2.*

Proof. We think of $K \subset S^3$ as being in the boundary of B^4 . Draw r unlinked unknots beside D , each with framing $+1$. This is a Kirby diagram which represents K as a knot in the boundary of the “blown up” four-ball $X = B^4 \# r\mathbb{C}\mathbb{P}^2$. As observed in [3], the knot K bounds a disk Δ in X . This may be seen from the diagram by sliding each of the chosen crossings in D over a $+1$ -framed unknot as in Figure 5. Mark each of these changed crossings with a small arc α_i , $i = 1, \dots, r$, as shown in that figure.

The resulting diagram consists of:

- an unknot U which has been obtained from K by crossing changes;
- arcs $\alpha_1, \dots, \alpha_r$ (one per changed crossing);
- $+1$ -framed unknots $\gamma_1, \dots, \gamma_r$.

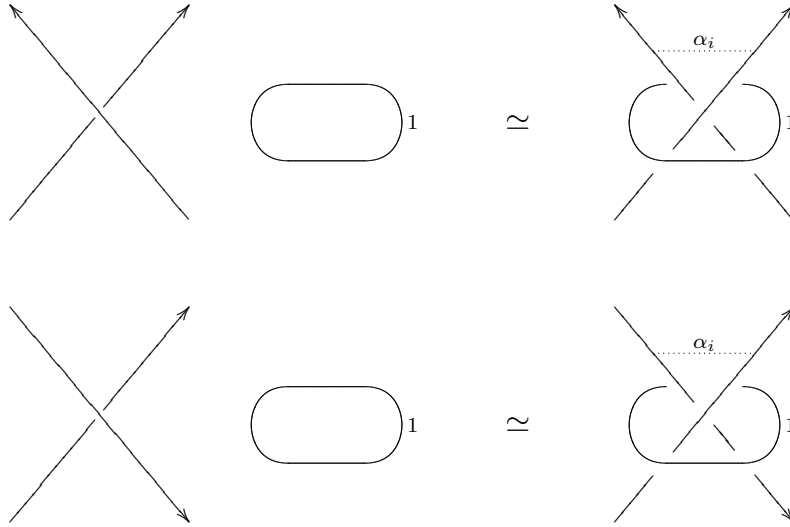

Fig. 5. **Changing crossings by sliding over a two-handle.**

Each γ_i bounds a disk D_i which retracts onto α_i and whose intersection with U consists of the endpoints of α_i .

It is also observed in [3] that $H_1(X - \Delta; \mathbb{Z}/2) \cong \mathbb{Z}/2$, with generator given by the meridian of K . (To see this note from Figure 5 that the linking number of U with each of the $+1$ -framed unknots is even. Now use the Mayer-Vietoris sequence for the decomposition of X into $X - \Delta$ and a neighbourhood of Δ , with $\mathbb{Z}/2$ coefficients.) Thus there exists a unique double cover W of X branched along Δ ; this is a four-manifold with boundary $\Sigma(K)$.

Rearrange the diagram so that a point of U which is not the endpoint of an arc α_i is the point at infinity and U is a vertical line; then Δ may be seen in this diagram as the half-plane to the left of U . (For a simple example see the first 3 diagrams in Figure 7. Note in general the arcs α_i may be knotted and linked, and may intersect Δ .) We may rearrange the diagram so that all intersections of γ_i and Δ look like one of the diagrams on the left of Figure 6. To draw a Kirby diagram of W , we simply need to take two copies of $S^3 - U$ cut open along Δ , and join the boundary half-planes in pairs. Or in other words: take the part of the diagram to the right of U , and draw another copy of it to the left of U . (Think of rotating the half plane to the right of U about U by π , *not* reflecting.) Complete the centre of the diagram using Figure 6. (For an example see Figure 7.)

Each arc α_i lifts to a knot $\tilde{\alpha}_i$, and each D_i lifts to an annulus \tilde{D}_i with core $\tilde{\alpha}_i$. The knot γ_i lifts to two knots C_i, C'_i ; these are the boundary of the annulus \tilde{D}_i .

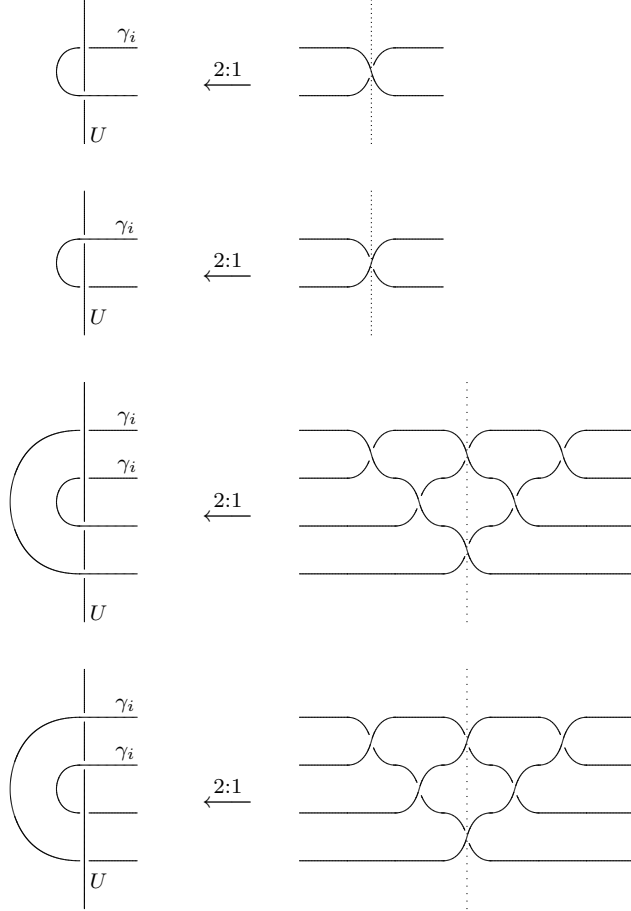

Fig. 6. **Drawing the double branched cover.** Here Δ is the half-plane to the left of U . The dotted line in the diagrams on the right is the preimage of U . The top two diagrams occur at endpoints of α_i , and the bottom two occur where α_i intersects the interior of Δ .

We now compute the framings of C_i, C'_i . The 0-framing on γ_i lies on the disk D_i , and lifts to a curve on the annulus \tilde{D}_i . This is the same framing for C_i (or C'_i) as the other boundary curve of \tilde{D}_i , but with the opposite sign. Thus the 0-framing on γ_i lifts to the $-\text{lk}(C_i, C'_i)$ -framing on each of C_i, C'_i . Then the framing $+1$ on γ_i lifts to m_i on each of C_i, C'_i , where $\text{lk}(C_i, C'_i) = 1 - m_i$.

We note that the resulting Kirby diagram for W matches that in Lemma 2.2 (ii). That lemma then shows that $\Sigma(K) = \partial W$ is Dehn surgery on the framed link $L = C_1, \dots, C_r$ with framing $(2m_i - 1)/2$ on C_i . \square

To prove that the matrix Q is positive-definite under the hypotheses of Theorem 3 one may appeal to [3, Theorem 3.7], which gives a formula for the signature of the four-manifold W constructed in Lemma 3.1. Surprisingly however it is also possible to prove this using the following purely three-dimensional argument.

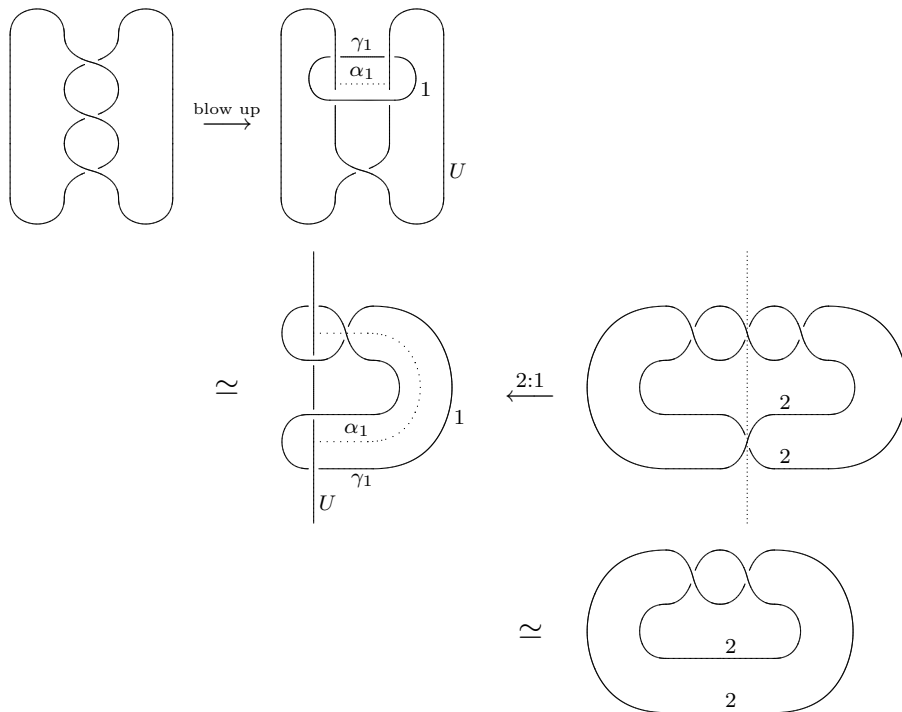

Fig. 7. A four-manifold bounded by the double branched cover of the left-handed trefoil.

Lemma 3.2 *Suppose that K may be unknotted by changing p positive and n negative crossings, with $n = \sigma(K)/2$. Let $\Sigma(K)$ be given by Dehn surgery on a link C_1, \dots, C_{p+n} with linking matrix $\frac{1}{2}Q$ as in Lemma 3.1. Then Q is positive-definite, and exactly n of the diagonal entries of Q are congruent to 3 modulo 4.*

Proof. The positivity of Q is proved in [17, Theorem 8.1] for the case of unknotting number one knots, i.e. $p+n = 1$. We include the proof of this case here for completeness.

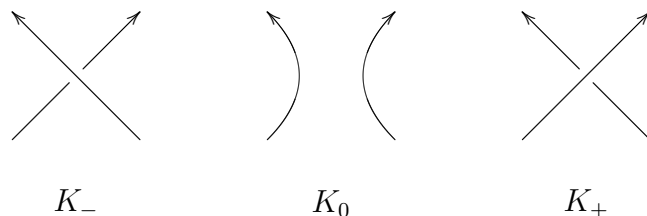

Fig. 8.

Suppose K_- , K_0 and K_+ are links in S^3 which are identical outside of a ball in which they appear as in Figure 8. Recall that the double cover of a ball B branched along two arcs is a solid torus \tilde{B} , and a meridian for the solid torus

is given by the preimage in \tilde{B} of either of the arcs pushed out to the boundary of B . It follows that $\Sigma(K_-)$, $\Sigma(K_0)$, $\Sigma(K_+)$ each contain an embedded solid torus, such that the complements of these solid tori can be identified. The meridians which bound in $\Sigma(K_-)$, $\Sigma(K_0)$, $\Sigma(K_+)$ are shown in Figure 9. They may be oriented so that their homology classes intersect as follows:

$$\mu_- \cdot \mu_+ = 2, \quad \mu_+ \cdot \mu_0 = \mu_- \cdot \mu_0 = 1. \quad (8)$$

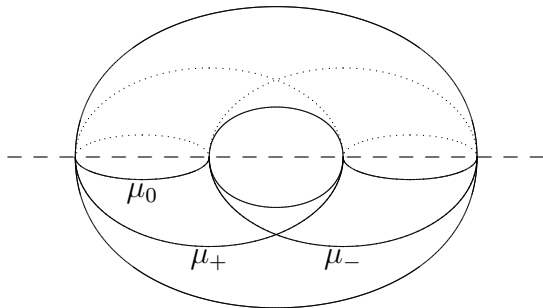

Fig. 9. **Meridians in $\Sigma(K_-)$, $\Sigma(K_0)$, $\Sigma(K_+)$.** Rotating by π around the horizontal axis gives the solid torus as the double cover of a ball branched along the arcs in K_0 .

Suppose now that $K = K_-$ with $\sigma(K) = 2$, and K_+ is the unknot. Then $\Sigma(K_+) = S^3$, and $\Sigma(K_-)$ is $(2m - 1)/2$ surgery on some knot C . We wish to show that m is positive and even. For some longitude λ of C with $\mu_+ \cdot \lambda = 1$ we have

$$\mu_- = -2\lambda - (2m - 1)\mu_+.$$

Expressing λ in the basis μ_+ , μ_0 and plugging into (8) yields $\lambda = \mu_0 - m\mu_+$, from which we see that $\mu_0 = \lambda + m\mu_+$. In other words, $\Sigma(K_0)$ is m surgery on C .

We now use two properties of the Conway-normalised Alexander polynomial, cf. [9]. Firstly, for a knot K , the sign of the Alexander polynomial at -1 is given by

$$(-1)^{\sigma(K)/2} \det K = \Delta_K(-1).$$

This shows that $\Delta_{K_+}(-1) = 1$ and $\Delta_{K_-}(-1) = -|2m - 1|$. Secondly we have the skein relation

$$\Delta_{K_+}(t) - \Delta_{K_-}(t) = (t^{-1/2} - t^{1/2})\Delta_{K_0}(t),$$

which yields

$$1 + |2m - 1| = 2|m|.$$

It follows that m and $2m - 1$ are both positive. Finally, the determinant and signature of a knot K are shown in [11, Theorem 5.6] to satisfy

$$\det(K) \equiv \sigma(K) + 1 \pmod{4}, \quad (9)$$

from which it follows that $2m - 1$ is congruent to 3 modulo 4.

Similarly if K_- is the unknot and $\sigma(K_+) = 0$, we have that $\Sigma(K_+)$ is $(2m-1)/2$ surgery on a knot C and we find $\Sigma(K_0)$ is $(m - 1)$ surgery on C . The skein relation gives $|2m - 1| - 1 = 2|m - 1|$, which again shows m is positive. From (9) we have $2m - 1$ is congruent to 1 modulo 4.

The general case follows easily from the above. Let c_1, \dots, c_{p+n} be the set of crossings (p positive, n negative) in some chosen diagram that we change to unknot K . Then $\Sigma(K)$ is Dehn surgery on a link $L = C_1, \dots, C_{p+n}$, with linking matrix $\frac{1}{2}Q$. Each C_i corresponds to a crossing c_i . Dehn surgery on a sublink of L gives the double branched cover of a knot which is obtained from K by changing a subset of the crossings in \mathcal{C} . In particular $Q_{ii}/2$ surgery on the knot C_i yields the double branched cover of the knot K' which is obtained from K by changing all of the crossings except c_i . It follows from the unknotting number one case applied to K' that all diagonal entries of Q are positive and exactly those which correspond to negative crossings are congruent to 3 modulo 4.

It remains to prove that Q is positive-definite. Note that from (1) and the assumption $n = \sigma(K)/2$, the knot signature changes every time we change a negative crossing and is unchanged when we change a positive crossing. Let Q_k be the submatrix $(Q_{ij})_{i,j \leq k}$. Observe that since the off-diagonal entries are even, the determinant of Q_k is congruent modulo 4 to the product of the diagonal entries. Let K_k be the knot obtained from K by changing the crossings c_{k+1}, \dots, c_{p+n} . Suppose that $\det Q_{k-1}$ is positive, and hence equals $\det K_{k-1}$. If c_k is positive then

$$Q_{kk} \equiv 1 \implies \det Q_k \equiv \det Q_{k-1} \pmod{4}.$$

Also (9) implies that the determinants of K_k and K_{k-1} are congruent modulo 4. It follows that $\det Q_k \equiv \det K_k \pmod{4}$. Since $\det Q_k$ and $\det K_k$ are equal up to sign and odd, $\det Q_k$ must be positive.

On the other hand if c_k is a negative crossing then

$$\det Q_k \equiv \det Q_{k-1} + 2, \quad \det K_k \equiv \det K_{k-1} + 2 \pmod{4},$$

and we again find $\det Q_k$ to be positive. By induction $\det Q_k$ is positive for all k . \square

Finally note that we may reorient any of the link components C_1, \dots, C_{p+n} without changing the resulting Dehn surgery. Also by rational handlesliding as in Proposition 2.1 we may change the linking matrix by “adding” $\pm 2C_j$ to C_i for any i, j . These operations preserve the congruence classes modulo 4 of the diagonal. We may also reorder the link components. The last claim in the statement of Theorem 3 now follows from the following lemma.

Lemma 3.3 *Any matrix $P \in GL(r, \mathbb{Z})$ which is congruent to a permutation matrix modulo 2 may be obtained from a permutation matrix by a sequence of row operations, each of which is either multiplying a row by -1 or adding an even multiple of one row to another.*

Proof. Let $\mathbf{b} = (b_1, \dots, b_r)$ be an element of \mathbb{Z}^r with $\gcd(b_1, \dots, b_r) = 1$. Assume $b_i \geq 0$ for all i , and that b_1 is odd but the other components b_2, \dots, b_r are even. Let b_j be the least positive component. By subtracting even multiples of b_j and then possibly changing sign, we may replace every other component b_i by b'_i , with $0 \leq b'_i \leq b_j$. By the gcd condition, the least positive b'_i is less than b_j unless $b_j = j = 1$. By iterating this procedure we see that \mathbf{b} may be reduced to $(1, 0, \dots, 0)$.

Now suppose $P \in GL(r, \mathbb{Z})$ is congruent to I modulo 2, and let \mathbf{b} be the first column of P . The argument just given shows that P may be replaced by a matrix with $(1, 0, \dots, 0)$ in the first column using the specified row operations. Then replacing the second column with $(*, 1, 0, \dots, 0)$ by row operations on the last $r - 1$ rows, and so on, we see that we may reduce P to I in this manner.

Finally if P is congruent modulo 2 to a permutation matrix, then it is the product of a matrix congruent to the identity and a permutation matrix. \square

4 Heegaard Floer homology

In this section we recall some properties of the Heegaard Floer homology invariants of Ozsváth and Szabó. Details are to be found in their papers, in particular [15–17].

Let Y be an oriented rational homology three-sphere. Recall that the space $\text{Spin}^c(Y)$ of spin^c structures on Y is isomorphic to $H^2(Y; \mathbb{Z})$. If $|H^2(Y; \mathbb{Z})|$ is odd then there is a canonical isomorphism which takes the unique spin structure to zero; this gives $\text{Spin}^c(Y)$ a group structure.

Fixing a spin^c structure \mathfrak{s} , the Heegaard Floer homology $HF^+(Y; \mathfrak{s})$ is a \mathbb{Q} -graded abelian group with an action by $\mathbb{Z}[U]$, where U lowers the grading

by 2. The *correction term* invariant is a rational number $d(Y, \mathfrak{s})$; it is defined to be the lowest grading of a nonzero homogeneous element of $HF^+(Y; \mathfrak{s})$ which is in the image of U^n for all $n \in \mathbb{N}$. These have the property that $d(Y, \mathfrak{s}) = -d(-Y, \mathfrak{s})$, where $-Y$ denotes Y with the opposite orientation. We will describe below how these correction terms may be computed in certain cases.

Now let X be a positive-definite four-manifold with boundary Y . Then it is shown in [15] that for any spin^c structure \mathfrak{s} on X ,

$$c_1(\mathfrak{s})^2 - b_2(X) \geq 4d(Y, \mathfrak{s}|_Y), \quad (10)$$

$$\text{and } c_1(\mathfrak{s})^2 - b_2(X) \equiv 4d(Y, \mathfrak{s}|_Y) \pmod{2}. \quad (11)$$

This means that the correction terms of Y may be used to give an obstruction to Y bounding a four-manifold X with a given positive-definite intersection form. We will now elaborate on how this may be checked in practice.

Suppose for simplicity that X is simply-connected and that $|H^2(Y; \mathbb{Z})|$ is odd. Let r denote the second Betti number of X . Fix a basis for $H_2(X; \mathbb{Z})$ and thus an isomorphism

$$H_2(X; \mathbb{Z}) \cong \mathbb{Z}^r.$$

Let Q be the matrix of the intersection pairing of X in this basis; thus Q is a symmetric positive-definite $r \times r$ integer matrix with $\det Q = |H^2(Y; \mathbb{Z})|$. The dual basis gives an isomorphism between the second cohomology $H^2(X; \mathbb{Z})$ and \mathbb{Z}^r . The set $\{c_1(\mathfrak{s}) \mid \mathfrak{s} \in \text{Spin}^c(X)\} \subset H^2(X; \mathbb{Z})$ of first Chern classes of spin^c structures is equal to the set of characteristic covectors $\text{Char}(Q)$ for Q . These in turn are elements ξ of \mathbb{Z}^r whose components ξ_i are congruent modulo 2 to the corresponding diagonal entries Q_{ii} of Q . The square of the first Chern class of a spin^c structure is computed using the pairing induced by Q on $H^2(X; \mathbb{Z})$; in our choice of basis this is given by $\xi^T Q^{-1} \xi$.

The long exact sequence of the pair (X, Y) yields the following short exact sequence:

$$0 \longrightarrow \mathbb{Z}^r \xrightarrow{Q} \mathbb{Z}^r \longrightarrow H^2(Y; \mathbb{Z}) \longrightarrow 0.$$

As in the introduction, define a function

$$m_Q : \mathbb{Z}^r / Q(\mathbb{Z}^r) \rightarrow \mathbb{Q}$$

by

$$m_Q(g) = \min \left\{ \frac{\xi^T Q^{-1} \xi - r}{4} \mid \xi \in \text{Char}(Q), [\xi] = g \right\}.$$

In computing m_Q it suffices to consider characteristic covectors $\xi = (\xi_1, \dots, \xi_r)$ whose components are smaller in absolute value than the corresponding diag-

onal entries of Q :

$$-Q_{ii} \leq \xi_i \leq Q_{ii}.$$

If, say, $\xi_i > Q_{ii}$, subtract twice the i th column of Q from ξ to see that $\xi^T Q^{-1} \xi$ is not minimal. A more difficult argument in [16] shows that it suffices to restrict to

$$-Q_{ii} \leq \xi_i \leq Q_{ii} - 2.$$

Thus it is straightforward, if tedious, to compute m_Q for a given positive-definite matrix Q .

The conditions (10) and (11) may now be expressed as follows:

Theorem 4.1 (Ozsváth-Szabó) *Let Y be a rational homology three-sphere which is the boundary of a simply-connected positive-definite four-manifold X , with $|H^2(Y; \mathbb{Z})|$ odd. If the intersection pairing of X is represented in a basis by the matrix Q then there exists a group isomorphism*

$$\phi : \mathbb{Z}^r / Q(\mathbb{Z}^r) \rightarrow \text{Spin}^c(Y)$$

with

$$m_Q(g) \geq d(Y, \phi(g)), \tag{12}$$

$$\text{and } m_Q(g) \equiv d(Y, \phi(g)) \pmod{2} \tag{13}$$

for all $g \in \mathbb{Z}^r / Q(\mathbb{Z}^r)$.

The four-manifold X is said to be *sharp* if equality holds in (12). In this case the correction terms for Y can be computed using the function m_Q described above. Also, if a rational homology sphere Y bounds a negative-definite four-manifold X such that $-X$ is sharp, then the correction terms for Y can be computed using the formula $d(Y, \mathfrak{s}) = -d(-Y, \mathfrak{s})$. Note that if K is a knot in S^3 then the standard orientation on S^3 induces an orientation on $\Sigma(K)$; letting $r(K)$ denote the reflection of K , we have $\Sigma(r(K)) \cong -\Sigma(K)$.

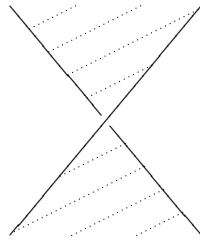

Fig. 10. Colouring convention for alternating knot diagrams.

In particular let K be an alternating knot with double branched cover $\Sigma(K)$. Let G denote the positive-definite Goeritz matrix computed from an alternating diagram for K as follows. Colour the knot diagram in chessboard fashion

according to the convention shown in Figure 10. (Note that this is the opposite convention to that used in [17], since they use the negative-definite Goeritz matrix.) The white (Tait) graph is the planar graph with a vertex in each white region of the diagram, and an edge between two vertices for each crossing connecting the corresponding white regions. Let v_1, \dots, v_{k+1} denote the vertices of the white graph. Then G is the $k \times k$ symmetric matrix (g_{ij}) with entries

$$g_{ij} = \begin{cases} \text{the number of edges containing } v_i & \text{if } i = j \\ \text{minus the number of edges joining } v_i \text{ and } v_j & \text{if } i \neq j \end{cases}$$

for $i, j = 1, \dots, k$. It is shown in [17, Proposition 3.2] that G represents the intersection pairing of a sharp four-manifold bounded by $\Sigma(K)$. Thus the correction terms for $\Sigma(K)$ are given by m_G (for any choice of alternating diagram and any ordering of the white regions). Also it follows from [4] that with this colouring convention, the signature of K is given by

$$\sigma(K) = k - \mu,$$

where μ is the number of positive crossings in the alternating diagram used to compute G .

Also if K is a Montesinos knot then the double branched cover $\Sigma(K)$ is a Seifert fibred space which is given as the boundary of a plumbing of disk bundles over S^2 . This plumbing is determined (nonuniquely) by the Montesinos invariants which specify K . After possibly reflecting K we may choose the plumbing so that its intersection pairing is represented by a positive-definite matrix P . It is shown in [16] that the plumbing is sharp, so that the correction terms for $\Sigma(K)$ are given by m_P . (See [12] for a description of Montesinos knots and their branched double covers.)

Remark 4.2 *Checking the congruence condition (11) alone is equivalent to checking that the intersection pairing of X presents the linking pairing of Y ; see [14] for a detailed discussion.*

5 Obstruction to unknotting

In this section we prove Theorems 1 and 5.

Let $\mathcal{Q}(r, \delta)$ denote the set of positive-definite symmetric integer matrices of rank r and determinant δ , on which $GL(r, \mathbb{Z})$ acts by $P \cdot Q = PQP^T$ with finite quotient (see e.g. [2]). Let $\mathcal{Q}(r, \delta)_2 \subset \mathcal{Q}(r, \delta)$ denote the subset consisting of matrices which are congruent to the identity modulo 2, and let

$\mathcal{G}(r) \subset GL(r, \mathbb{Z})$ denote the subgroup consisting of matrices which are congruent modulo 2 to a permutation matrix.

Then the subset $\mathcal{Q}(r, \delta)_2/GL(r, \mathbb{Z})$ is clearly finite, and thus so is $\mathcal{Q}(r, \delta)_2/\mathcal{G}(r)$ since $\mathcal{G}(r)$ is a finite index subgroup of $GL(r, \mathbb{Z})$.

Proof of Theorem 5. By Theorem 3, the unknotting hypothesis implies that $\Sigma(K)$ is given by Dehn surgery on a link in S^3 with linking matrix $\frac{1}{2}Q_i$ for some i , where n of the diagonal entries of Q_i are congruent to 3 modulo 4. By Lemma 2.2, $\Sigma(K)$ bounds the 2-handlebody W specified by an integer-framed link with positive-definite linking matrix \tilde{Q}_i , which then represents the intersection pairing of W . The conclusion now follows from Theorem 4.1. \square

Proof of Theorem 1. Theorem 1 follows from Theorem 5 since a finite set of representatives of $\mathcal{Q}(2, \delta)_2/\mathcal{G}(2)$ is given by the set of matrices

$$\left\{ Q = \begin{pmatrix} 2m_1 - 1 & 2a \\ 2a & 2m_2 - 1 \end{pmatrix} \mid \det Q = \delta, 0 \leq a < m_1, m_2 \right\},$$

and since the correction terms $d(\Sigma(K), \mathfrak{s})$ may be computed using a positive-definite Goeritz matrix G when K is alternating. \square

Remark 5.1 *Theorems 1 and 5 do not use all of the information from Theorem 3. We have only used the information about the intersection pairing of the four-manifold W bounded by $\Sigma(K)$, and not the fact that W is a surgery cobordism arising from a half-integral surgery. Comparing to Theorem 1.1 in [17], we have generalised conditions (1) and (2) to the case of $u(K) > 1$ but not the symmetry condition (3). It is to be hoped that the symmetry condition may also be generalised in some way, leading to a stronger obstruction and computation of some more unknotting numbers.*

6 Examples

Proof of Corollary 2. For each knot in Corollary 2 we distinguish between K and its reflection $r(K)$ by specifying that K has positive signature.

We start with the knot $K = 9_{10}$ shown in Figure 11. This is the two-bridge knot $S(33, 23)$. It has signature 4, and it is easy to see that 3 crossing changes

suffice to unknot it. Thus the unknotting number is either 2 or 3, and if it can be unknotted by changing two crossings then both are negative ($p = 0$ and $n = 2$).

With the white regions labelled as shown in the figure, the Goeritz matrix is

$$G = \begin{pmatrix} 4 & -1 & 0 & 0 \\ -1 & 2 & -1 & 0 \\ 0 & -1 & 2 & -1 \\ 0 & 0 & -1 & 4 \end{pmatrix}.$$

Using m_G , we find the correction terms of $\Sigma(K)$ to be:

$$A = \left\{ \begin{array}{cccccccccccc} -1, & -\frac{23}{33}, & \frac{7}{33}, & -\frac{3}{11}, & -\frac{5}{33}, & \frac{19}{33}, & -\frac{1}{11}, & -\frac{5}{33}, & \frac{13}{33}, & -\frac{5}{11}, & -\frac{23}{33}, \\ -\frac{1}{3}, & \frac{7}{11}, & \frac{7}{33}, & \frac{13}{33}, & \frac{13}{11}, & \frac{19}{33}, & \frac{19}{33}, & \frac{13}{11}, & \frac{13}{33}, & \frac{7}{33}, & \frac{7}{11}, \\ -\frac{1}{3}, & -\frac{23}{33}, & -\frac{5}{11}, & \frac{13}{33}, & -\frac{5}{33}, & -\frac{1}{11}, & \frac{19}{33}, & -\frac{5}{33}, & -\frac{3}{11}, & \frac{7}{33}, & -\frac{23}{33} \end{array} \right\}.$$

The order of this list corresponds to the cyclic group structure of

$$\Gamma_G \cong \text{Spin}^c(\Sigma(K)) \cong H^2(\Sigma(K); \mathbb{Z}) \cong \mathbb{Z}/33,$$

and the first element is the correction term of the spin structure.

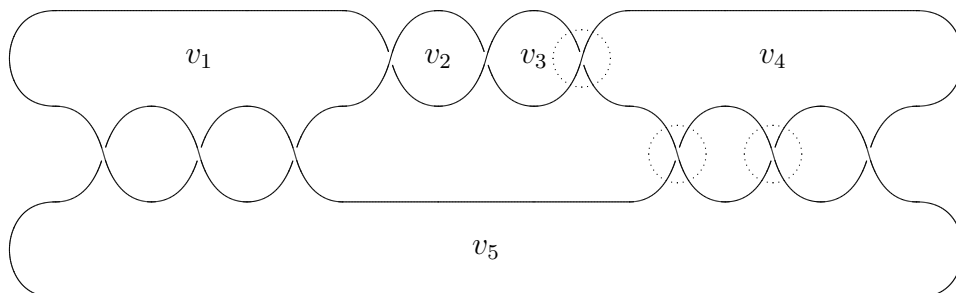

Fig. 11. **The knot** $9_{10} = S(33, 23)$. Note that changing the circled crossings will give the unknot. The labels v_1, \dots, v_5 correspond to vertices of the white graph.

The determinant of 9_{10} is 33. To find a matrix \tilde{Q} as in Theorem 1 we need to

find (m_1, a, m_2) with

$$(2m_1 - 1)(2m_2 - 1) - 4a^2 = 33,$$

$$0 \leq a < m_1 \leq m_2,$$

and m_1 and m_2 are even. There are two solutions: $(2, 0, 6)$ and $(4, 2, 4)$. Computing $m_{\tilde{Q}}$ for each of the matrices

$$\tilde{Q}_1 = \begin{pmatrix} 2 & 1 & 0 & 0 \\ 1 & 2 & 0 & 0 \\ 0 & 0 & 6 & 1 \\ 0 & 0 & 1 & 2 \end{pmatrix}, \quad \tilde{Q}_2 = \begin{pmatrix} 4 & 1 & 2 & 0 \\ 1 & 2 & 0 & 0 \\ 2 & 0 & 4 & 1 \\ 0 & 0 & 1 & 2 \end{pmatrix}$$

yields the following lists:

$$B_1 = \left\{ \begin{array}{l} -1, -\frac{5}{33}, \frac{13}{33}, \frac{7}{11}, \frac{19}{33}, \frac{7}{33}, -\frac{5}{11}, \frac{19}{33}, \frac{43}{33}, -\frac{3}{11}, -\frac{5}{33}, \\ -\frac{1}{3}, -\frac{9}{11}, \frac{13}{33}, \frac{43}{33}, -\frac{1}{11}, \frac{7}{33}, \frac{7}{33}, -\frac{1}{11}, \frac{43}{33}, \frac{13}{33}, -\frac{9}{11}, \\ -\frac{1}{3}, -\frac{5}{33}, -\frac{3}{11}, \frac{43}{33}, \frac{19}{33}, -\frac{5}{11}, \frac{7}{33}, \frac{19}{33}, \frac{7}{11}, \frac{13}{33}, -\frac{5}{33} \end{array} \right\},$$

$$B_2 = \left\{ \begin{array}{l} -1, -\frac{19}{33}, \frac{23}{33}, \frac{9}{11}, -\frac{7}{33}, -\frac{13}{33}, \frac{3}{11}, -\frac{7}{33}, \frac{5}{33}, -\frac{7}{11}, -\frac{19}{33}, \\ \frac{1}{3}, \frac{1}{11}, \frac{23}{33}, \frac{5}{33}, \frac{5}{11}, -\frac{13}{33}, -\frac{13}{33}, \frac{5}{11}, \frac{5}{33}, \frac{23}{33}, \frac{1}{11}, \\ \frac{1}{3}, -\frac{19}{33}, -\frac{7}{11}, \frac{5}{33}, -\frac{7}{33}, \frac{3}{11}, -\frac{13}{33}, -\frac{7}{33}, \frac{9}{11}, \frac{23}{33}, -\frac{19}{33} \end{array} \right\}.$$

In each case the order of the list corresponds to the group structure of $\Gamma_{\tilde{Q}_i} \cong \mathbb{Z}/33$, with the first element being the image of the identity under $m_{\tilde{Q}_i}$. We claim that for both \tilde{Q}_1 and \tilde{Q}_2 it is impossible to find a group automorphism ϕ of $\mathbb{Z}/33$ satisfying the required inequality and congruence conditions. This is immediate in either case by considering the minimal elements (excluding -1 which appears in all 3 lists). We have the entry $-9/11$ in B_1 . By inspection there is no element in A which is less than or equal to $-9/11$, and differs from it by a multiple of 2. The same applies to $-7/11$ in B_2 . We conclude that 9_{10} cannot be unknotted by two crossing changes and $u(9_{10}) = 3$.

Similar calculations show that $9_{13}, 9_{38}, 10_{53}, 10_{101}$ and 10_{120} cannot be unknotted with two crossing changes. All of these knots are alternating, have signa-

ture four and cyclic $H^2(\Sigma(K); \mathbb{Z})$. By inspection of their diagrams (see e.g. [1]), all can be unknotted with three crossing changes. For some details of the calculations for these knots, see Table 1. Note that we use the knot diagrams from [1] to compute the Goeritz matrices for these knots, after possibly reflecting to ensure positive signature.

Finally consider $K = 9_{35}$, pictured in Figure 12. It has signature 2 and can be unknotted with 3 crossing changes. The Goeritz matrix from the figure is

$$G = \begin{pmatrix} 6 & -3 \\ -3 & 6 \end{pmatrix}.$$

We note that this presents $H^2(\Sigma(K); \mathbb{Z})$ which is thus isomorphic to $\mathbb{Z}/3 \oplus \mathbb{Z}/9$; this shows (by Montesinos' theorem for example but by an inequality originally due to Wendt) that $u(K) \geq 2$. We can use m_G to compute the correction terms of $\Sigma(K)$, which are

$$A = \begin{bmatrix} -\frac{1}{2} & \frac{19}{18} & -\frac{5}{18} & \frac{3}{2} & \frac{7}{18} & \frac{7}{18} & \frac{3}{2} & -\frac{5}{18} & \frac{19}{18} \\ \frac{1}{6} & -\frac{5}{18} & \frac{7}{18} & \frac{1}{6} & \frac{19}{18} & \frac{19}{18} & \frac{1}{6} & \frac{7}{18} & -\frac{5}{18} \\ \frac{1}{6} & -\frac{5}{18} & \frac{7}{18} & \frac{1}{6} & \frac{19}{18} & \frac{19}{18} & \frac{1}{6} & \frac{7}{18} & -\frac{5}{18} \end{bmatrix}.$$

Here the rectangular array shows the $\mathbb{Z}/3 \oplus \mathbb{Z}/9$ group structure; the top left entry is the correction term of the spin structure.

Suppose that 9_{35} may be unknotted by changing one positive and one negative crossing. The only matrix which satisfies the conditions of Theorem 1 and which presents $\mathbb{Z}/3 \oplus \mathbb{Z}/9$ is

$$\tilde{Q} = \begin{pmatrix} 2 & 1 & 0 & 0 \\ 1 & 2 & 0 & 0 \\ 0 & 0 & 5 & 1 \\ 0 & 0 & 1 & 2 \end{pmatrix}.$$

Computing $m_{\tilde{Q}}$ yields another array whose minimal entry is $-17/18$; we conclude that there is no automorphism ϕ of $\mathbb{Z}/3 \oplus \mathbb{Z}/9$ satisfying the conclusion of Theorem 1.

This is not enough to rule out the possibility that $u(9_{35}) = 2$; it does however show that if 9_{35} can be unknotted by two crossing changes, then they are both

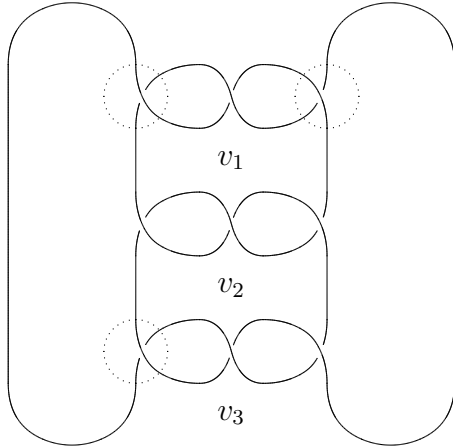

Fig. 12. **The Montesinos knot** $9_{35} = M(0; (3, 1), (3, 1), (3, 1))$.

negative crossings. Using the value of the Jones polynomial at $e^{i\pi/3}$, Traczyk has shown in [19] that if 9_{35} can be unknotted by changing two crossings, then the crossings have different signs. We conclude that $u(9_{35}) = 3$. \square

Proof of Corollary 6. The two-bridge knot $K = S(51, 35)$ is listed in [1] as $11a365$ and is shown in Figure 13. It has signature 6, and from the diagram we see that it may be unknotted by changing 4 crossings. We will apply Theorem 5 to show that it does not have $u(K) = n = 3$.

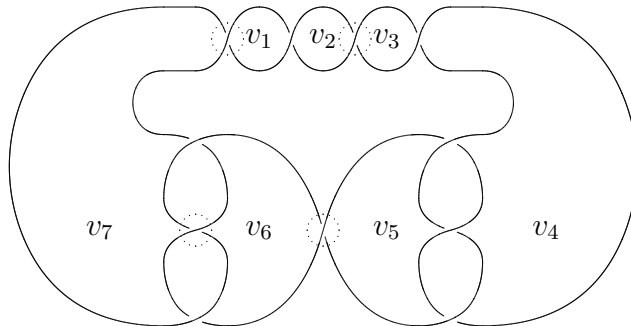

Fig. 13. **The two-bridge knot** $S(51, 35)$, or $11a365$.

Note that $\det K = 51$. We will use the notation from Section 5. In order to apply Theorem 5 we first need to find a set of representatives of the finite quotient $\mathcal{Q}(3, 51)_2/\mathcal{G}(3)$ with all diagonal entries conjugate to 3 modulo 4. According to [7], a complete set of representatives of $\mathcal{Q}(3, 51)/GL(3, \mathbb{Z})$ is

given by the (Eisenstein reduced) matrices

$$\begin{pmatrix} 1 & 0 & 0 \\ 0 & 1 & 0 \\ 0 & 0 & 51 \end{pmatrix}, \begin{pmatrix} 1 & 0 & 0 \\ 0 & 2 & 1 \\ 0 & 1 & 26 \end{pmatrix}, \begin{pmatrix} 1 & 0 & 0 \\ 0 & 3 & 0 \\ 0 & 0 & 17 \end{pmatrix}, \begin{pmatrix} 1 & 0 & 0 \\ 0 & 4 & 1 \\ 0 & 1 & 13 \end{pmatrix}, \begin{pmatrix} 1 & 0 & 0 \\ 0 & 5 & 2 \\ 0 & 2 & 11 \end{pmatrix}, \begin{pmatrix} 1 & 0 & 0 \\ 0 & 6 & 3 \\ 0 & 3 & 10 \end{pmatrix},$$

$$\begin{pmatrix} 2 & 0 & 1 \\ 0 & 3 & 0 \\ 1 & 0 & 9 \end{pmatrix}, \begin{pmatrix} 2 & 1 & 0 \\ 1 & 2 & 0 \\ 0 & 0 & 17 \end{pmatrix}, \begin{pmatrix} 3 & 0 & 1 \\ 0 & 3 & 0 \\ 1 & 0 & 6 \end{pmatrix}, \begin{pmatrix} 3 & 1 & 1 \\ 1 & 4 & 0 \\ 1 & 0 & 5 \end{pmatrix}, \begin{pmatrix} 4 & 1 & 2 \\ 1 & 4 & 2 \\ 2 & 2 & 5 \end{pmatrix}.$$

Note that if $P \in GL(3, \mathbb{Z})$ satisfies $PP^T \equiv I \pmod{2}$, then P is conjugate to a permutation matrix modulo 2. Thus if $P \in GL(3, \mathbb{Z})$ and $Q, PQP^T \in \mathcal{Q}(3, 51)_2$ then Q and PQP^T have the same number of diagonal entries conju-

gate to 3 modulo 4. We therefore eliminate the forms represented by $\begin{pmatrix} 1 & 0 & 0 \\ 0 & 1 & 0 \\ 0 & 0 & 51 \end{pmatrix}$,

$\begin{pmatrix} 1 & 0 & 0 \\ 0 & 3 & 0 \\ 0 & 0 & 17 \end{pmatrix}$, $\begin{pmatrix} 1 & 0 & 0 \\ 0 & 5 & 2 \\ 0 & 2 & 11 \end{pmatrix}$. For each remaining form in the list, we look for a basis

in which the form is congruent to the identity modulo 2. If no such basis exists, or if we find that some diagonal entry is not conjugate to 3 modulo 4, we eliminate the form. This leaves us with the following four forms to consider:

$$\begin{pmatrix} 1 & 0 & 0 \\ 0 & 2 & 1 \\ 0 & 1 & 26 \end{pmatrix} \sim \begin{pmatrix} 3 & 2 & 0 \\ 2 & 27 & 26 \\ 0 & 26 & 27 \end{pmatrix}, \begin{pmatrix} 1 & 0 & 0 \\ 0 & 6 & 3 \\ 0 & 3 & 10 \end{pmatrix} \sim \begin{pmatrix} 11 & 4 & -6 \\ 4 & 7 & 4 \\ -6 & 4 & 11 \end{pmatrix}, \begin{pmatrix} 2 & 1 & 0 \\ 1 & 2 & 0 \\ 0 & 0 & 17 \end{pmatrix} \sim \begin{pmatrix} 19 & 18 & 18 \\ 18 & 19 & 16 \\ 18 & 16 & 19 \end{pmatrix},$$

$$\text{and } \begin{pmatrix} 3 & 0 & 1 \\ 0 & 3 & 0 \\ 1 & 0 & 6 \end{pmatrix} \sim \begin{pmatrix} 3 & 0 & -2 \\ 0 & 3 & 0 \\ -2 & 0 & 7 \end{pmatrix}.$$

From Figure 13 we may write down the Goeritz matrix G ; the correction terms $\{d(\Sigma(K), \mathfrak{s})\}$ are then given by m_G . For each Q in

$$\left\{ \begin{pmatrix} 3 & 2 & 0 \\ 2 & 27 & 26 \\ 0 & 26 & 27 \end{pmatrix}, \begin{pmatrix} 11 & 4 & -6 \\ 4 & 7 & 4 \\ -6 & 4 & 11 \end{pmatrix}, \begin{pmatrix} 19 & 18 & 18 \\ 18 & 19 & 16 \\ 18 & 16 & 19 \end{pmatrix}, \begin{pmatrix} 3 & 0 & -2 \\ 0 & 3 & 0 \\ -2 & 0 & 7 \end{pmatrix} \right\},$$

one may check that there is no isomorphism

$$\phi : \Gamma_{\tilde{Q}} \rightarrow \text{Spin}^c(\Sigma(K))$$

satisfying the conclusion of Theorem 5. We conclude that the unknotting number of K is 4. \square

Remark 6.1 *In the last step of the proof of Corollary 6 it is much quicker in some cases to change basis before computing $m_{\tilde{Q}}$, so as to work with a matrix*

with smaller diagonal entries. For example with $Q = \begin{pmatrix} 19 & 18 & 18 \\ 18 & 19 & 16 \\ 18 & 16 & 19 \end{pmatrix}$, we have

$$\tilde{Q} = \begin{pmatrix} 10 & 1 & 9 & 0 & 9 & 0 \\ 1 & 2 & 0 & 0 & 0 & 0 \\ 9 & 0 & 10 & 1 & 8 & 0 \\ 0 & 0 & 1 & 2 & 0 & 0 \\ 9 & 0 & 8 & 0 & 10 & 1 \\ 0 & 0 & 0 & 0 & 1 & 2 \end{pmatrix} \sim \begin{pmatrix} 10 & 1 & -1 & 0 & -1 & 0 \\ 1 & 2 & -1 & 0 & -1 & 0 \\ -1 & -1 & 2 & 1 & 0 & 0 \\ 0 & 0 & 1 & 2 & 0 & 0 \\ -1 & -1 & 0 & 0 & 2 & 1 \\ 0 & 0 & 0 & 0 & 1 & 2 \end{pmatrix},$$

by subtracting the first basis vector from the third and fifth. As a result we need to consider $2^5 \cdot 10$ characteristic covectors to compute $m_{\tilde{Q}}$ instead of $2^3 \cdot 10^3$.

Table 1

Data for knots in Corollary 2. The fourth column contains possible coefficients of the matrix \tilde{Q} in Theorem 1.

Knot	Goeritz matrix	$\min_{g \neq 0} \{m_G(g)\}$	(m_1, a, m_2)	$\min_{g \neq 0} \{m_{\tilde{Q}}(g)\}$
9_{13}	$\begin{pmatrix} 2 & -1 & 0 & 0 \\ -1 & 2 & -1 & 0 \\ 0 & -1 & 4 & -1 \\ 0 & 0 & -1 & 4 \end{pmatrix}$	$-\frac{27}{37}$	$(10, 9, 10)$	$-\frac{33}{37}$
9_{38}	$\begin{pmatrix} 4 & -1 & -1 & 0 \\ -1 & 4 & -2 & 0 \\ -1 & -2 & 4 & -1 \\ 0 & 0 & -1 & 2 \end{pmatrix}$	$-\frac{37}{57}$	$(2, 0, 10)$ $(6, 4, 6)$	$-\frac{51}{57}$ $-\frac{45}{57}$
10_{53}	$\begin{pmatrix} 4 & -1 & 0 & 0 \\ -1 & 4 & -1 & -1 \\ 0 & -1 & 4 & -1 \\ 0 & -1 & -1 & 2 \end{pmatrix}$	$-\frac{53}{73}$	$(4, 1, 6)$	$-\frac{59}{73}$
10_{101}	$\begin{pmatrix} 2 & -1 & 0 & 0 \\ -1 & 4 & -1 & -1 \\ 0 & -1 & 4 & -1 \\ 0 & -1 & -1 & 4 \end{pmatrix}$	$-\frac{59}{85}$	$(6, 3, 6)$ $(22, 21, 22)$	$-\frac{65}{85}$ $-\frac{81}{85}$
10_{120}	$\begin{pmatrix} 4 & -2 & 0 & -1 \\ -2 & 4 & -1 & 0 \\ 0 & -1 & 4 & -2 \\ -1 & 0 & -2 & 4 \end{pmatrix}$	$-\frac{69}{105}$	$(2, 0, 18)$ $(4, 0, 8)$ $(6, 2, 6)$ $(10, 8, 10)$	$-\frac{99}{105}$ $-\frac{91}{105}$ $-\frac{83}{105}$ $-\frac{93}{105}$

References

- [1] J. C. Cha & C. Livingston, *Table of knot invariants*, <http://www.indiana.edu/~knotinfo>.
- [2] J. W. S. Cassels, *Rational quadratic forms*, Academic Press, 1978.
- [3] T. D. Cochran & W. B. R. Lickorish, *Unknotting information from 4-manifolds*, Trans. Amer. Math. Soc. **297** 1986, 125–142.
- [4] C. McA. Gordon & R. A. Litherland, *On the signature of a link*, Invent. Math. **47** 1978, 53–69.
- [5] C. McA. Gordon & J. Luecke, *Knots with Unknotting Number 1 and Essential Conway Spheres*, Algebraic & Geometric Topology **6** 2006, 2051–2116.
- [6] R. E. Gompf & A. I. Stipsicz, *4-manifolds and Kirby calculus*, Graduate Studies in Math. **20**, Amer. Math. Soc., 1999.
- [7] B. W. Jones, *A table of Eisenstein-reduced positive ternary quadratic forms of determinant ≤ 200* , National Research Council Bulletin **97** 1935.
- [8] W. B. R. Lickorish, *The unknotting number of a classical knot*, Contemp. Math. **44** 1985, 117–121.
- [9] W. B. R. Lickorish, *An introduction to knot theory*, Graduate Texts in Math. **175**, Springer, 1997.
- [10] J. M. Montesinos, *Surgery on links and double branched coverings of S^3* , Ann. of Math. Studies **84** 1975, 227–259.
- [11] K. Murasugi, *On a certain numerical invariant of link types*, Trans. Amer. Math. Soc. **117** 1965, 387–422.
- [12] B. Owens & S. Strle, *Rational homology spheres and the four-ball genus of knots*, Advances in Mathematics **200** 2006, 196–216.
- [13] B. Owens & S. Strle, *A characterisation of the $n\langle 1 \rangle \oplus \langle 3 \rangle$ form and applications to rational homology spheres*, Math. Res. Lett. **13** 2006, 259–271.
- [14] B. Owens & S. Strle, *Definite manifolds bounded by rational homology three spheres*, Geometry and Topology of Manifolds, Fields Inst. Communications **47**, Amer. Math. Soc., 2005, 243–252.
- [15] P. Ozsváth & Z. Szabó, *Absolutely graded Floer homologies and intersection forms for four-manifolds with boundary*, Advances in Mathematics **173** 2003, 179–261.
- [16] P. Ozsváth & Z. Szabó, *On the Floer homology of plumbed three-manifolds*, Geometry and Topology **7** 2003, 225–254.
- [17] P. Ozsváth & Z. Szabó, *Knots with unknotting number one and Heegaard Floer homology*, Topology **44** 2005, 705–745.

- [18] A. Stoimenow. *Polynomial values, the linking form and unknotting numbers*, Math. Res. Lett. **11** 2004, 755–769.
- [19] P. Traczyk. *A criterion for signed unknotting number*, Low-dimensional topology (Funchal, 1998), Contemp. Math. **233**, Amer. Math. Soc., 1999, 215–220.