

Covering link calculus and the bipolar filtration of topologically slice links

JAE CHOON CHA
MARK POWELL

The bipolar filtration introduced by T Cochran, S Harvey and P Horn is a framework for the study of smooth concordance of topologically slice knots and links. It is known that there are topologically slice 1–bipolar knots which are not 2–bipolar. For knots, this is the highest known level at which the filtration does not stabilize. For the case of links with two or more components, we prove that the filtration does not stabilize at any level: for any n , there are topologically slice links which are n –bipolar but not $(n + 1)$ –bipolar. In the proof we describe an explicit geometric construction which raises the bipolar height of certain links exactly by one. We show this using the covering link calculus. Furthermore we discover that the bipolar filtration of the group of topologically slice string links modulo smooth concordance has a rich algebraic structure.

[57M25](#), [57N70](#)

1 Introduction

Since the stunning work of S Donaldson and M Freedman in the early 1980s, the smoothing of topological 4–manifolds has been a central subject in low-dimensional topology. While there have been significant advances in this area, we are still far from having a complete understanding of it. An experimental lab for the study of this difference in categories is the comparison between smooth and topological concordance of knots and links in S^3 . In this context various techniques, from Donaldson and Seiberg–Witten theory to more recent tools arising from Heegaard Floer and Khovanov homology, have been used to give exciting results. In particular, since A Casson observed that Donaldson’s work could be applied to show that there are topologically slice knots which are not smoothly slice, smooth concordance of topologically slice knots and links has been studied extensively.

In order to understand the structure of topologically slice knots and links, T Cochran, S Harvey and P Horn introduced a framework for the study of smooth concordance in their recent paper [9]. This is an intriguing attempt at describing a global picture of the

world of topologically slice links. They defined the notion of n -bipolarity of knots and links, as an approximation to honest slicing whose accuracy is measured in terms of the derived series of the fundamental group of slice disk complements in certain positive/negative-definite 4-manifolds. For a precise definition, see [Definition 2.1](#) or [\[9, Definition 2.1\]](#). This refines Cochran–Orr–Teichner’s (n) -solvable filtration which organizes the study of topological concordance. Note that a topologically slice link is (n) -solvable for all n , so that the solvable filtration contains no information about the difference in categories.

For each m , the collection \mathcal{T}_n of concordance classes of *topologically slice* n -bipolar links with m components form a filtration

$$\{\text{unlink}\} \subset \cdots \subset \mathcal{T}_2 \subset \mathcal{T}_1 \subset \mathcal{T}_0 \subset \mathcal{T} = \frac{\{\text{topologically slice } m\text{-component links}\}}{\text{concordance}}.$$

A smoothly slice link lies in \mathcal{T}_n for all n . An important feature which helps to justify this theory is that previously known smooth concordance obstructions are related to the low-level terms. In particular, for 1-bipolar knots the following obstructions to being slice vanish: the τ -invariant and the ϵ -invariant from Heegaard Floer Knot homology, the s -invariant from the Khovanov homology (and consequently the Thurston–Bennequin invariant), and the Heegaard Floer correction term d -invariant of ± 1 -surgery manifolds and prime power fold cyclic branched covers, as well as gauge-theoretic obstructions derived from work of Fintushel–Stern, Furuta, Endo and Kirk–Hedden. For more details the reader is referred to [\[9\]](#).

A fundamental question is whether the filtration is non-trivial at every level. This is difficult to answer because, as discussed above, known smooth invariants vanish in the higher terms of the filtration. The best previously known result, due to [\[9; 10\]](#), is that

$$\mathcal{T}_2 \subsetneq \mathcal{T}_1 \subsetneq \mathcal{T}_0 \subsetneq \mathcal{T}$$

for knots. That is, for $n = -1, 0, 1$, there are topologically slice n -bipolar knots which are not $(n + 1)$ -bipolar, where for convenience “topologically slice (-1) -bipolar” is understood as “topologically slice”. Consequently, for links with any given number of components, the filtration is non-trivial at level n for each $n \leq 1$. The knots of Hedden–Livingston–Ruberman from [\[16\]](#), which were the first examples of topologically slice knots which are not smoothly concordant to knots with Alexander polynomial one, are also nontrivial in $\mathcal{T}/\mathcal{T}_0$.

The main result of this paper is to show the non-triviality of the filtration at every level for links.

Theorem 1.1 *For any $m \geq 2$ and $n \geq 0$, there are topologically slice m -component links which are n -bipolar but not $(n + 1)$ -bipolar.*

We remark that, for $n \geq 1$, the links which we exhibit in the proof of [Theorem 1.1](#) have unknotted components.

In order to prove [Theorem 1.1](#), we introduce the notion of a $\mathbb{Z}_{(p)}$ -homology n -bipolar link ([Definition 2.3](#)) and employ the method of *covering link calculus* following the formulation in [5]. An n -bipolar link is $\mathbb{Z}_{(p)}$ -homology n -bipolar for all primes p . The key ingredient ([Theorem 3.2](#)), which we call the *Covering positon/negaton theorem*, is that a covering link of a $\mathbb{Z}_{(p)}$ -homology n -bipolar link of height k is $\mathbb{Z}_{(p)}$ -homology $(n - k)$ -bipolar.

An interesting aspect of the proof of [Theorem 1.1](#) is that our examples are described explicitly using a geometric operation, which pushes a link into a higher level of the bipolar filtration. For this purpose it is useful to consider the notion of the *bipolar height* of a link, which is defined by

$$\text{BH}(L) = \max\{n \mid L \text{ is } n\text{-bipolar}\}.$$

Using the Covering positon/negaton theorem and the calculus of covering links, we show that for certain class of links our geometric operation raises the bipolar height (and its $\mathbb{Z}_{(p)}$ -homology analogue) precisely by one; see [Definitions 4.2, 4.4 and 4.5](#) and [Theorem 4.6](#) for more details. This enables us to push the rich structure of \mathcal{T}_0 modulo \mathcal{T}_1 , which was revealed by Cochran and Horn for the knot case in [10] using d -invariants, to an arbitrarily high level of the bipolar filtration of links.

For links, the concordance classes merely form a set, of which $\{\mathcal{T}_n\}$ is a filtration by subsets, since the connected sum operation is not well defined. The standard approach to generalize the algebraic structure of the knot concordance group is to consider *string links*. The concordance classes of string links with m components form a group, and it turns out that the classes of topologically slice string links with n -bipolar closures form a normal subgroup, which we denote by $\mathcal{T}_n^{\text{SL}}(m)$. We discuss more details at the beginning of [Section 5](#). This bipolar filtration of topologically slice string links has a rich algebraic structure:

Theorem 1.2 *For any $n \geq 0$ and for any $m \geq 2$, the quotient $\mathcal{T}_n^{\text{SL}}(m)/\mathcal{T}_{n+1}^{\text{SL}}(m)$ contains a subgroup whose abelianization is of infinite rank.*

Once again, for $n \geq 1$ these subgroups are generated by string links with unknotted components.

In the proof of [Theorem 1.2](#), we introduce a string link version of covering link construction which behaves nicely with respect to the group structure; see for instance [Definition 5.2](#) and [Lemma 5.3](#). We employ a more involved calculus of covering string

links than that used in the ordinary links case. So far as the authors know, this is the first use of covering link calculus to investigate the structure of the string link concordance group. We anticipate that our method for string links will be useful for further applications.

The paper is organized as follows: In [Section 2](#) we give the definition of a $\mathbb{Z}_{(p)}$ -homology n -bipolar link, and prove some basic results about this notion. In [Section 3](#) we discuss the covering link calculus, and prove the Covering positon/negaton theorem. We also prove some preliminary results on Bing doubles, using covering link calculus results for Bing doubles from the literature. In [Section 4](#) we prove the bipolar height raising result, exhibit our main examples, and thus prove [Theorem 1.1](#).

[Section 5](#) considers string links and proves [Theorem 1.2](#).

[Appendices A](#) and [B](#) give results on the use of Levine–Tristram signatures and Von Neumann ρ -invariants respectively to obstruct a link being $\mathbb{Z}_{(p)}$ -homology n -bipolar.

Conventions All manifolds are smooth and submanifolds are smoothly embedded, with the exception of the locally flat disks which are tacitly referred to when we claim that a link is topologically slice. If not specified, then homology groups are with \mathbb{Z} coefficients by default. The letter p always denotes a prime number.

Acknowledgements The authors would like to thank Tim Cochran and Shelly Harvey for interesting conversations about their filtration. The authors also thank an anonymous referee for helpful comments. The first author was partially supported by NRF grants 2010-0011629, 2013067043 and 2013053914.

2 Homology n -positive, negative and bipolar links

An (oriented) m -component link $L = L_1 \sqcup \cdots \sqcup L_m$ is a smooth disjoint embedding of m (oriented) copies of S^1 into S^3 . Two links L and L' are said to be *smoothly* (resp. *topologically*) *concordant* if there are m disjoint smoothly (resp. locally flat) embedded annuli C_i in $S^3 \times I$ with $\partial C_i = L_i \times \{0\} \sqcup -L'_i \times \{1\}$. Here $-L'$ is the mirror image of L' with the string orientation reversed. A link which is concordant to the unlink is said to be *slice*.

In [\[9\]](#), Cochran, Harvey and Horn introduced the notion of n -positivity, negativity and bipolarity.

Definition 2.1 [9, Definition 2.2] An m -component link L in S^3 is n -positive if S^3 bounds a connected 4-manifold V satisfying the following:

- (1) $\pi_1(V) \cong 0$.
- (2) There are disjoint smoothly embedded 2-disks $\Delta_1, \dots, \Delta_m$ in V that satisfy $\bigsqcup \partial\Delta_i = L$.
- (3) The intersection pairing on $H_2(V)$ is positive-definite and there are disjointly embedded connected surfaces S_j in $V - \bigsqcup \Delta_i$ which generate $H_2(V)$ and satisfy $\pi_1(S_j) \subset \pi_1(V - \bigsqcup \Delta_i)^{(n)}$.

We call V as above an n -positon for L with slicing disks Δ_i . An n -negative link and an n -negaton are defined by replacing “positive-definite” with “negative-definite”. A link L is called n -bipolar if L is both n -positive and n -negative.

For our purpose the following homology analogue of Definition 2.1 provides an optimum setting.

Throughout this paper p denotes a fixed prime. Therefore, as in Definition 2.2, we often omit the p from the notation. In the statements of theorems also we omit that the theorem holds for all primes p . At the end of the paper, in the proof of Theorem 5.1, we need to restrict to $p = 2$ for d -invariant computational reasons, but until then p can be any fixed prime.

We denote the localization of \mathbb{Z} at p by $\mathbb{Z}_{(p)} = \{a/b \in \mathbb{Q} \mid p \nmid b\}$, and the ring $\mathbb{Z}/p\mathbb{Z}$ of mod p residue classes by \mathbb{Z}_p . Note that a manifold is a \mathbb{Z}_p -homology sphere if and only if it is a $\mathbb{Z}_{(p)}$ -homology sphere.

Definition 2.2 We define the $\mathbb{Z}_{(p)}$ -coefficient derived series $\{\mathcal{P}^n G\}$ of a group G as follows: $\mathcal{P}^0 G := G$ and

$$\mathcal{P}^{n+1} G := \text{Ker} \left(\mathcal{P}^n G \rightarrow \frac{\mathcal{P}^n G}{[\mathcal{P}^n G, \mathcal{P}^n G]} \rightarrow \frac{\mathcal{P}^n G}{[\mathcal{P}^n G, \mathcal{P}^n G]} \otimes_{\mathbb{Z}} \mathbb{Z}_{(p)} \cong H_1(\mathcal{P}^n G; \mathbb{Z}_{(p)}) \right).$$

From the definition it can be seen that $\mathcal{P}^n G$ is a normal subgroup of G for any n .

We remark that a more general case of the mixed-coefficient derived series was defined in [2]. It should also be noted that our $\mathbb{Z}_{(p)}$ -coefficient derived series is not equal to the \mathbb{Z}_p -coefficient analogue, namely the series obtained by replacing $\mathbb{Z}_{(p)}$ with \mathbb{Z}_p , which appeared in the literature as well; $\mathcal{P}^n G / \mathcal{P}^{n+1} G$ is the maximal abelian quotient of $\mathcal{P}^n G$ which has no torsion coprime to p , while the corresponding quotient of the \mathbb{Z}_p -coefficient analogue is the maximal abelian quotient which is a \mathbb{Z}_p -vector space.

Definition 2.3 ($\mathbb{Z}_{(p)}$ -homology n -positivity, negativity and bipolarity) Suppose L is an m -component link in a $\mathbb{Z}_{(p)}$ -homology 3-sphere Y . We say that (Y, L) is $\mathbb{Z}_{(p)}$ -homology n -positive if Y bounds a connected 4-manifold V satisfying the following:

- (1) $H_1(V; \mathbb{Z}_{(p)}) = 0$.
- (2) There are disjointly embedded 2-disks $\Delta_1, \dots, \Delta_m$ in V with $\bigsqcup \partial \Delta_i = L$.
- (3) The intersection pairing on $H_2(V)/\text{torsion}$ is positive definite and there are disjointly embedded connected surfaces S_j in $V - \bigsqcup \Delta_i$ which generate the group $H_2(V)/\text{torsion}$ and satisfy $\pi_1(S_j) \subset \mathcal{P}^n \pi_1(V - \bigsqcup \Delta_i)$.

We call V as above a $\mathbb{Z}_{(p)}$ -homology n -positon for (Y, L) with slicing disks Δ_i . A $\mathbb{Z}_{(p)}$ -homology n -negative link and a $\mathbb{Z}_{(p)}$ -homology n -negaton are defined by replacing “positive definite” with “negative definite.” We say that (Y, L) is $\mathbb{Z}_{(p)}$ -homology n -bipolar if (Y, L) is both $\mathbb{Z}_{(p)}$ -homology n -positive and $\mathbb{Z}_{(p)}$ -homology n -negative.

For a commutative ring R (eg $R = \mathbb{Z}$ or \mathbb{Q}), the R -homology analogues are defined by replacing $\mathbb{Z}_{(p)}$ with R in the above definitions.

We note that whether a link is $\mathbb{Z}_{(p)}$ -homology n -positive depends on the choice of the ambient space; it is conceivable that, for example, even when (Y, L) is not $\mathbb{Z}_{(p)}$ -homology n -positive, $(Y \# Y', L)$ could be. Nonetheless, when the choice of the ambient space Y is clearly understood, we often say that L is $\mathbb{Z}_{(p)}$ -homology n -positive, and similarly for the negative/bipolar case.

When we need to distinguish n -positive (resp. negative, bipolar) links in [Definition 2.1](#) explicitly from the $\mathbb{Z}_{(p)}$ -homology case in [Definition 2.2](#), we call the former *homotopy n -positive* (resp. negative, bipolar). It is easy to see that homotopy n -positive (resp. negative, bipolar) links are R -homology n -positive (resp. negative, bipolar) for any R .

2.1 Zero-framing and 0-positivity/negativity

In this paper, we need some basic facts on framings of components of links in rational homology spheres (for example to define branched covers). For the reader's convenience we discuss these in some detail, focusing on the 0-positive/negative case.

The following lemma gives the basic homological properties of a $\mathbb{Z}_{(p)}$ -homology 0-positon (or negaton). Since an n -positon, for $n > 0$, is in particular a 0-positon, this will suffice.

Lemma 2.4 Suppose V is a $\mathbb{Z}_{(p)}$ -homology 0-positon (or negaton) for an m -component link L with slicing disks Δ_i . Then the following hold:

- (1) The first homology $H_1(V - \bigsqcup \Delta_i; \mathbb{Z}_{(p)})$ is a free $\mathbb{Z}_{(p)}$ -module of rank m generated by the meridians of L .
- (2) The inclusion induces an isomorphism of $H_2(V - \bigsqcup \Delta_i; \mathbb{Z}_{(p)})$ onto $H_2(V; \mathbb{Z}_{(p)})$, which is a free $\mathbb{Z}_{(p)}$ -module generated by the surfaces S_j in [Definition 2.3](#).

The following elementary observations are useful: commutative localizations are flat, so

$$H_*(-; \mathbb{Z}_{(p)}) \cong H_*(-) \otimes \mathbb{Z}_{(p)},$$

and for a finitely generated abelian group A , we have

$$\begin{aligned} A \otimes \mathbb{Z}_{(p)} \cong (\mathbb{Z}_{(p)})^d &\iff A \cong \mathbb{Z}^d \oplus (\text{torsion coprime to } p) \\ &\iff A \otimes \mathbb{Q} \cong \mathbb{Q}^d \text{ and } A \otimes \mathbb{Z}_{p^a} \cong (\mathbb{Z}_{p^a})^d \text{ for any } a. \end{aligned}$$

In addition, if these equivalent conditions hold, then for elements $x_1, \dots, x_d \in A$, $\{x_i \otimes 1\}$ is a basis of $A \otimes \mathbb{Z}_{(p)}$ if and only if $\{x_i \otimes 1\}$ is a basis of $A \otimes \mathbb{Z}_{p^a}$ and $\{x_i \otimes 1\}$ is a basis of $A \otimes \mathbb{Q}$. This gives us the following consequences of [Lemma 2.4](#): the torsion part of $H_1(V - \bigsqcup \Delta_i)$ has order coprime to p , and for $R = \mathbb{Z}_{p^a}$ and \mathbb{Q} , $H_1(V - \bigsqcup \Delta_i; R)$ is isomorphic to the free R -module R^m generated by the meridians. Similar conclusions hold for $H_2(V - \bigsqcup \Delta_i; -)$ and $H_2(V; -)$.

Proof of Lemma 2.4 First we claim that $H_2(V)$ has no p -torsion. To see this, note that since ∂V is a \mathbb{Z}_p -homology sphere and $H_1(V; \mathbb{Z}_{(p)}) = 0$ implies $H_1(V; \mathbb{Z}_p) = 0$, we have $H_3(V; \mathbb{Z}_p) \cong H^1(V, \partial V; \mathbb{Z}_p) \cong H^1(V; \mathbb{Z}_p) = 0$. By the universal coefficient theorem, $H_3(V; \mathbb{Z}_p)$ surjects onto $\text{Tor}(H_2(V), \mathbb{Z}_p)$. The vanishing of this latter group implies the claim.

From the above claim it follows that the quotient map $H_2(V) \rightarrow H_2(V)/\text{torsion}$ induces an isomorphism $H_2(V; \mathbb{Z}_{(p)}) = H_2(V) \otimes \mathbb{Z}_{(p)} \cong (H_2(V)/\text{torsion}) \otimes \mathbb{Z}_{(p)}$. Let S_j be the surfaces given in [Definition 2.3](#). Since $S_j \subset V - \bigsqcup \Delta_i$ and the classes of S_j span $H_2(V)/\text{torsion}$, it follows that $H_2(V - \bigsqcup \Delta_i; \mathbb{Z}_{(p)}) \rightarrow H_2(V; \mathbb{Z}_{(p)})$ is surjective. From the long exact sequence for $(V, V - \bigsqcup \Delta_i)$ and excision it follows that

$$\begin{aligned} H_1\left(V - \bigsqcup \Delta_i; \mathbb{Z}_{(p)}\right) &\cong H_2\left(V, V - \bigsqcup \Delta_i; \mathbb{Z}_{(p)}\right) \\ &\cong \bigoplus_i H_2(\Delta_i \times (D^2, S^1); \mathbb{Z}_{(p)}) \cong (\mathbb{Z}_{(p)})^m, \end{aligned}$$

where this is generated by the meridians of the Δ_i . This shows (1).

Now, for (2), consider the $\mathbb{Z}_{(p)}$ -coefficient Mayer–Vietoris sequence for $V \simeq (V - \bigsqcup \Delta_i) \cup (2\text{-cells})$, where the 2-cells are attached along each meridian. (Alternatively, consider the long exact sequence for $(V, V - \bigsqcup \Delta_i)$.) By (1), the desired conclusion easily follows. \square

A framing of a submanifold is a choice of trivialization of its normal bundle. Generalizing the case of knots in S^3 , a framing f of a knot K in a rational homology sphere Y is called the *zero-framing* if the rational-valued linking number of K with its longitude (= a parallel copy) taken along f is zero. We state some facts on the zero-framing. For the proofs, see [3, Chapter 2], [6, Section 3].

- (1) A knot K in a rational homology sphere has a zero framing if and only if the \mathbb{Q}/\mathbb{Z} -valued self-linking of K vanishes. This follows from [3, Theorem 2.6 (2)], noting that a knot admits a generalized Seifert surface with respect to some framing if and only if that framing is the zero framing, by [6, Lemma 3.1].
- (2) A framing f on K in Y is a zero-framing if and only if there is a map $g: Y - K \rightarrow S^1$ under which the longitude (= a parallel copy) taken along f is sent to a null-homotopic curve and the image of a meridian μ of K is sent to an essential curve. Furthermore, $g_*([\mu]) \in \mathbb{Z} = \pi_1(S^1)$ is coprime to p if Y is a $\mathbb{Z}_{(p)}$ -homology 3-sphere. This follows from elementary obstruction theory and the same observation as above, namely that zero-framing is equivalent to the existence of a generalized Seifert surface.

From the above it follows that if a knot K in a $\mathbb{Z}_{(p)}$ -homology 3-sphere Y admits a zero-framing and d is a power of p , then the d -fold cyclic branched cover of Y along K is defined. For, the above map g induces $\phi: \pi_1(Y - K) \rightarrow \mathbb{Z} \rightarrow \mathbb{Z}_d$ which gives a d -fold regular cover of $Y - K$. Under ϕ the meridian of K is sent to a generator of \mathbb{Z}_d , since d is a power of p . It follows that one can glue the d -fold cover of $Y - K$ with the standard branched covering of $K \times (D^2, 0)$ along the zero-framing to obtain the desired branched cover of Y along K .

Lemma 2.5 *A $\mathbb{Z}_{(p)}$ -homology 0-positive (or negative) knot K in a $\mathbb{Z}_{(p)}$ -homology sphere admits a zero-framing.*

Proof Suppose V is a $\mathbb{Z}_{(p)}$ -homology 0-positon for L with a slicing disk Δ . By appealing to Lemma 2.4(1), $H_1(V - \Delta)/\text{torsion}$ is isomorphic to an infinite cyclic group where the meridian of K is a nonzero power of the generator. This gives rise to a map $V - \Delta \rightarrow S^1$ by elementary obstruction theory. Let $g: Y - K \rightarrow S^1$ be its restriction. The longitude of K taken along the unique framing of the normal bundle of Δ is null-homotopic in $V - \Delta$, and consequently its image under g is null-homotopic in S^1 . \square

2.2 Basic operations on links

We state some observations on how positivity (resp. negativity, bipolarity) are affected by certain basic operations for links as the following theorem. Throughout this paper, $I = [0, 1]$. For two links $L \subset Y$ and $L' \subset Y'$, their *split union* is defined to be the link $L \sqcup L' \subset Y \# Y'$, where the connected sum is formed by choosing 3–balls disjoint to the links. For a link $L \subset Y$ and an embedding $\gamma: I \times I \rightarrow Y$ such that $\gamma(0 \times I)$ and $\gamma(1 \times I)$ are contained in distinct components of L and $\gamma((0, 1) \times I)$ is disjoint to L , a new link L' is obtained by smoothing the corners of $(L - \gamma(\{0, 1\} \times I)) \cup \gamma(I \times \{0, 1\})$. We say L' is obtained from L by *band sum* of components. When L is oriented, we assume that the orientation of $\gamma(\{0, 1\} \times I)$ is opposite to the orientations of L so that L' is oriented naturally. For a submanifold J , we denote the normal bundle by $\nu(J)$.

Theorem 2.6 *The following statements and their $\mathbb{Z}_{(p)}$ –homology analogues hold. In addition, the statements also hold if the words “positive” and “negative” are interchanged. Similarly the statements hold if both these words are replaced by “bipolar”, except for (9).*

- (1) (Mirror image) *A link is n –positive if and only if its mirror image is n –negative.*
- (2) (String orientation change) *A link is n –positive if and only if the link obtained by reversing orientation of any of the components is n –positive.*
- (3) (Split union) *The split union of two n –positive link is n –positive.*
- (4) (Sublink) *A sublink of an n –positive link is n –positive.*
- (5) (Band sum) *A link obtained by band sum of components from an n –positive link is n –positive.*
- (6) (Generalized cabling and doubling) *Suppose L_0 is a link in the standard $S^1 \times D^2 \subset S^3$ which is slice in the 4–ball, and L is an n –positive link with a component J . Then the link obtained from L by replacing $(\nu(J), J)$ with $(S^1 \times D^2, L_0)$ along the zero framing is n –positive.*
- (7) (Blow-down) *If L is an n –positive m –component link, then the $(m - 1)$ –component link in the (± 1) –framed (with respect to the zero–framing) surgery along a component of L is n –positive.*
- (8) (Concordance) *A link concordant to an n –positive link is n –positive. A slice link is n –bipolar for any n .*
- (9) (Crossing change) *If L is transformed to a 0–positive link by changing some positive crossings involving the same components to negative crossings, then L is 0–positive.*

We remark that due to [Theorem 2.6\(2\)](#) one may view knot and links as unoriented for the study of n -positivity (resp. negativity, bipolarity).

From [Theorem 2.6\(3\)](#) and [\(5\)](#) above, it follows that *any* connected sum of n -positive (resp. negative, bipolar) links is n -positive (resp. negative, bipolar). Moreover, by [Theorem 2.6\(2\)](#), by changing the orientation on one component before band summing, we can consider band sums which do not respect the orientation of a component. We have $\mathbb{Z}_{(p)}$ -homology analogues as well.

Proof Suppose V is an n -positon for L with slicing disks Δ_i .

(1) The 4-manifold V with reversed orientation is an n -negaton for the mirror image of L . Note that this makes it sufficient to consider only the positive case of the remaining statements: the negative case then follows from taking mirror image and the bipolar case from having both the positive and negative cases.

(2) As remarked above, the n -positon V and the slicing disks Δ_i satisfy [Definition 2.3](#) and its homotopy analogue independently of the orientations of components of L .

(3) The boundary connected sum of n -positons (along balls disjoint to links) is an n -positon of the split link.

(4) The 4-manifold V with appropriate slicing disks forgotten is an n -positon for a sublink.

(5) If L' is obtained from L by band sum, then L' and $-L$ cobound a disjoint union of annuli and a twice-punctured disk in $\partial V \times I$. Attaching it to V , we obtain an n -positon for L' .

(6) Note that $L_0 \subset S^1 \times D^2 \subset \partial(D^2 \times D^2)$ bounds slicing disks D_i in $D^2 \times D^2$ by the assumption. If Δ is a slicing disk for a component J of L , then identifying $\nu(\Delta)$ with $\Delta \times D^2 \cong D^2 \times D^2$ and replacing $(\nu(\Delta), \Delta)$ with $(D^2 \times D^2, \bigsqcup D_i)$ in V , we obtain slicing disks for the newly introduced components, and with these and the other slicing disks for L , V is an n -positon.

(7) Without loss of generality we can do surgery on the first component, say K_1 , of L_1 . Define a 4-manifold W to be $V - \nu(\Delta_1)$ with a 2-handle $D^2 \times D^2$ attached along the $\Delta_1 \times S^1$ part of the boundary of $V - \nu(\Delta_1)$, with an attaching map $S^1 \times D^2 \rightarrow \Delta_1 \times S^1$ chosen so that the resulting boundary 3-manifold is that given by performing surgery on L_1 using the (± 1) -framing. The 4-manifold W is an n -positon for the new link obtained by (± 1) -surgery along L_1 by the following argument. It can be seen that $\pi_1(W) \cong 0$ by the Seifert–Van Kampen theorem, since $\pi_1(V - \Delta_1)$ is normally generated by a meridian of K_1 and the zero-linking longitude of K_1 is null-homotopic

in $V - \nu(\Delta_1)$. We also see that $H_2(W) \cong H_2(V)$ by a Mayer–Vietoris argument, using Lemma 2.4(2). (This is true when V is a homotopy n -positon and a $\mathbb{Z}_{(p)}$ -homology n -positon.)

(8) If L' is concordant to L via disjoint embedded annuli C_i in $S^3 \times I$, then $V \cup_{S^3} S^3 \times I$ is an n -positon for L' with slicing disks $\Delta_i \cup C_i$. For a slice link L , the 4-ball with slicing disks is an n -positon (and negaton) for L for all n .

(9) This is shown by arguments of [11, Lemma 3.4].

The $\mathbb{Z}_{(p)}$ -homology analogues are shown by the same arguments. We note that when V is a $\mathbb{Z}_{(p)}$ -homology n -positon in (7), we have the following instead of $\pi_1(W) \cong 0$: $H_1(W; \mathbb{Z}_{(p)}) \cong H_1(V; \mathbb{Z}_{(p)}) \cong 0$ by a Mayer–Vietoris argument, since $H_1(V - \Delta_1; \mathbb{Z}_{(p)})$ is isomorphic to $\mathbb{Z}_{(p)}$ generated by a meridian by Lemma 2.4(1). \square

We remark that the operations in Theorem 2.6(2), (3), (4), (5) and (7) may be used (in various combinations) to obtain obstructions to links being positive (or negative, bipolar) from previously known results on knots. We discuss these results on knots below. In the later sections of this paper we will develop more sophisticated methods of reducing a problem from links to knots.

2.3 Obstructions to homology 0- and 1-positivity

Most of the obstructions to knots being 0- and 1-positive (resp. negative, bipolar) introduced in [9, Sections 4, 5, 6] generalize to their $\mathbb{Z}_{(p)}$ -homology analogues. For those who are not familiar with these results, we spell out the statements.

Theorem 2.7 (Obstructions to being $\mathbb{Z}_{(p)}$ -homology 0-positive; cf [9, Section 4]) *If a knot K in a $\mathbb{Z}_{(p)}$ -homology 3-sphere is $\mathbb{Z}_{(p)}$ -homology 0-positive, then the following hold:*

- (1) *The average function $\bar{\sigma}_K(\theta)$ of Cha–Ko’s signature [6] is nonpositive.*
- (2) *Ozsváth–Szabó–Rasmussen τ -invariant [22; 23] of K is nonnegative.*
- (3) *The (± 1) -surgery manifold, say N , of K bounds a 4-manifold W with positive definite intersection form on $H_2(W)/\text{torsion}$ and $H_1(W; \mathbb{Z}_p) = 0$. Consequently the Ozsváth–Szabó d -invariant [21] of N associated to its unique spin^c -structure is non-positive.*
- (4) *In addition, if $p = 2$ and $\bar{\sigma}_K(2\pi k/2^a) = 0$ for all k , then the Fintushel–Stern–Hedden–Kirk obstruction [15] associated to the 2^a -fold cyclic branched cover vanishes.*

Consequently, if K is $\mathbb{Z}_{(p)}$ -homology 0-bipolar, then $\bar{\sigma}_K(\theta) = 0$, $\tau(K) = 0$ and Hom's invariant $\epsilon(K) = 0$ [17].

We remark that in order to generalize the Levine–Tristram signature result in [9, Section 4], we employ, in Theorem 2.7(1), a generalization of the Levine–Tristram signature to knots in rational homology spheres which was introduced by Cha and Ko [6]. We give a description of the invariant $\bar{\sigma}_K$ and a proof of Theorem 2.7(1) in Appendix A.

The proofs of other parts of Theorem 2.7 and Theorem 2.8 stated below, are completely identical to those of the homotopy positive (resp. negative, bipolar) cases given in [9].

Theorem 2.8 (Obstruction to being $\mathbb{Z}_{(p)}$ -homology 1-positive [9, Section 6]) *Suppose K is a $\mathbb{Z}_{(p)}$ -homology 1-knot. Then the d -invariant of K associated to the p^a -fold cyclic branched cover M is nonpositive, in the following sense: for some metabolizer $H \subset H_1(M)$ (ie $|H|^2 = |H_1(M)|$) and the \mathbb{Q}/\mathbb{Z} -valued linking form vanishes on H) and a spin^c -structure s_0 on M corresponding to a spin-structure on M , $d(M, s_0 + \hat{z}) \leq 0$ for any $z \in H$, where \hat{z} is the Poincaré dual of z .*

Remark 2.9 Note that Theorem 2.8 also follows from our Covering positon theorem 3.2 that is stated and proved in Section 3: if we take a p^a -fold branched cover M of S^3 along K , then by Theorem 3.2, M bounds a $\mathbb{Z}_{(p)}$ -homology 0-position, to which a result of Ozsváth–Szabó [21] applies to allow us to conclude that the d -invariant of M with appropriate spin^c -structures is non-positive. Indeed our proof of Theorem 3.2 involves some arguments which are similar to those in [9, Section 6].

We do not know whether the Rasmussen s -invariant obstruction in [9] has a $\mathbb{Z}_{(p)}$ -homology analogue. Even the following weaker question is still left open.

Question 2.10 If a knot K is slice in a homology 4-ball (or more generally in a $\mathbb{Z}_{(p)}$ - or \mathbb{Q} -homology 4-ball), then does $s(K)$ vanish?

We can also relate $\mathbb{Z}_{(p)}$ -homology positivity to amenable von Neumann ρ -invariants, following the idea of [9, Section 5] and using techniques of [2]. We discuss this in more detail in Appendix B (see Theorem B.1).

3 Covering link calculus

We follow [5] to give a formal description of covering links. Suppose L is a link in a $\mathbb{Z}_{(p)}$ -homology 3-sphere Y . We consider the following two operations that give new

links: (C1) taking a sublink of L , and (C2) taking the pre-image of L in the p^a -fold cyclic cover of Y branched along a component of L with vanishing \mathbb{Q}/\mathbb{Z} -valued self-linking. Note that the p^a -fold cyclic branched cover is again a $\mathbb{Z}_{(p)}$ -homology sphere, by the argument of Casson and Gordon [1, Lemma 2].

Definition 3.1 A link \tilde{L} obtained from L by a finite sequence of the operations (C1) and/or (C2) above is called a p -covering link of L of height $\leq h$, where h is the number of (C2) operations.

Often we say that the link \tilde{L} in Definition 3.1 is a height h p -covering link. This is an abuse of terminology without the \leq sign; it is more appropriate to define the height of \tilde{L} to be minimum of the number of (C2) moves over all sequences of (C1) and (C2) operations which produce \tilde{L} from L . In all statements in this paper, this abuse does not cause any problem, since if we assign a height to a covering link which is not minimal, we obtain a weaker conclusion from Theorem 3.2 than is optimal.

We remark that for an oriented link L , a covering link \tilde{L} has a well-defined induced orientation. Since the choice of an orientation is irrelevant for the purpose of the study of n -positivity (or negativity, bipolarity) as discussed after Theorem 2.6, in this paper we also call a covering link with some component's orientation reversed a covering link.

3.1 Covering positon/negaton theorem

The main theorem of this section is the following:

Theorem 3.2 (Covering positon/negaton theorem) *For $n > k$, a height k p -covering link of a $\mathbb{Z}_{(p)}$ -homology n -positive (resp. negative, bipolar) link is $\mathbb{Z}_{(p)}$ -homology $(n - k)$ -positive (resp. negative, bipolar).*

We remark that this may be compared with the Covering solution theorem [4, Theorem 3.5] that provides a similar method for the n -solvable filtration of [12].

Proof It suffices to prove the positivity case. Suppose L is a link in a $\mathbb{Z}_{(p)}$ -homology 3-sphere Y , and V is a $\mathbb{Z}_{(p)}$ -homology n -positon for L with slicing disks Δ_i . It suffices to show the following:

- (1) A sublink of L is $\mathbb{Z}_{(p)}$ -homology n -positive.
- (2) Suppose $n > 0$, \tilde{Y} is a p^a -fold cyclic branched cover of Y along the first component of L , and \tilde{L} is the pre-image of L in \tilde{Y} . Then \tilde{L} is $\mathbb{Z}_{(p)}$ -homology $(n - 1)$ -positive.

Item (1) has been already discussed in [Theorem 2.6](#). To show (2), we first observe that by [Lemma 2.4](#)(1) applied to the first component as a sublink (see also the observation below [Lemma 2.4](#)), $H_1(V - \Delta_1; \mathbb{Z}_{p^a})$ is isomorphic to \mathbb{Z}_{p^a} and generated by a meridional curve of Δ_1 . Therefore we can define the p^a -fold cyclic branched cover of \tilde{V} of V along Δ_1 . In addition, since the inclusion induces an isomorphism $H_1(Y - \partial\Delta_1; \mathbb{Z}_{p^a}) \rightarrow H_1(V - \Delta_1; \mathbb{Z}_{p^a})$, it follows that $\partial\tilde{V}$ is the ambient space \tilde{Y} of the covering link L , by the above discussion on the zero-framing and branched covering construction for Y , namely [Lemma 2.5](#) and its preceding paragraph.

We will show that \tilde{V} is a $\mathbb{Z}_{(p)}$ -homology $(n - 1)$ -positon for \tilde{L} .

For notational convenience, we denote the pre-image of a subset $A \subset V$ under $\tilde{V} \rightarrow V$ by $\tilde{A} \subset \tilde{V}$. Observe that components of the $\tilde{\Delta}_i$ form disjoint slicing disks for \tilde{L} in \tilde{V} , since each Δ_i is simply connected. Let $\mu \subset V$ be a meridional circle for Δ_1 . Then $\tilde{\mu}$ is a meridional circle of the 2-disk $\tilde{\Delta}_1$. By [Lemma 2.4](#)(1), $H_1(V - \Delta_1, \mu; \mathbb{Z}_p) = 0$. From the following fact, it follows that $H_1(\tilde{V} - \tilde{\Delta}_1, \tilde{\mu}; \mathbb{Z}_p) \cong 0$.

Lemma 3.3 [[8](#), Corollary 4.10; [4](#), page 910] *Suppose G is a p -group and C_* is a projective chain complex over the group ring $\mathbb{Z}_p G$ with C_k finitely generated. Then, for any k , $\dim_{\mathbb{Z}_p} H_k(C_*) \leq |G| \cdot \dim_{\mathbb{Z}_p} H_k(\mathbb{Z}_p \otimes_{\mathbb{Z}_p G} C_*)$.*

That $H_1(\tilde{V} - \tilde{\Delta}_1, \tilde{\mu}; \mathbb{Z}_p) \cong 0$ implies that $H_1(\tilde{V} - \tilde{\Delta}_1, \tilde{\mu}; \mathbb{Z}_{(p)}) \cong 0$ and that $H_1(\tilde{V} - \tilde{\Delta}_1; \mathbb{Z}_{(p)})$ is generated by the class of $\tilde{\mu}$. It follows that $H_1(\tilde{V}; \mathbb{Z}_{(p)}) = 0$ since the homotopy type of \tilde{V} is obtained by attaching a 2-cell to $\tilde{V} - \tilde{\Delta}_1$ along $\tilde{\mu}$.

For later use, we also claim that $H_1(\tilde{V} - \tilde{\Delta}_1; \mathbb{Z}_{(p)}) \cong \mathbb{Z}_{(p)}$, generated by the class $[\tilde{\mu}]$. For, since the map $H_1(\tilde{V} - \tilde{\Delta}_1; \mathbb{Z}_{(p)}) \rightarrow H_1(V - \Delta_1; \mathbb{Z}_{(p)}) \cong \mathbb{Z}_{(p)}$ sends $[\tilde{\mu}]$ to $p^a[\mu]$, which is a multiple of a generator, $H_1(\tilde{V} - \tilde{\Delta}_1; \mathbb{Z}_{(p)})$ is not $\mathbb{Z}_{(p)}$ -torsion. The claim follows. A consequence is that $H_1(\tilde{V} - \tilde{\Delta}_1; \mathbb{Z}_p)$ is isomorphic to \mathbb{Z}_p and generated by $[\tilde{\mu}]$ (see the paragraph after [Lemma 2.4](#)).

Observe that the p^a -fold cover $\tilde{V} - \bigsqcup \tilde{\Delta}_i$ of $V - \bigsqcup \Delta_i$ has fundamental group

$$\pi_1(\tilde{V} - \bigsqcup \tilde{\Delta}_i) = \text{Ker}\{\pi_1(V - \bigsqcup \Delta_i) \rightarrow H_1(V - \bigsqcup \Delta_i)/\text{torsion} \cong \mathbb{Z}^m \rightarrow \mathbb{Z}_{p^a}\},$$

where final map sends the first meridian to $1 \in \mathbb{Z}_{p^a}$ and the other meridians to 0. (For convenience we view the fundamental group of a covering space as a subgroup of the fundamental group of its base space.) Also, from the definition we have

$$\mathcal{P}^1 \pi_1(V - \bigsqcup \Delta_i) = \text{Ker}\{\pi_1(V - \bigsqcup \Delta_i) \rightarrow H_1(V - \bigsqcup \Delta_i; \mathbb{Z}_{(p)})\},$$

where the above map with kernel $\mathcal{P}^1 \pi_1(V - \bigsqcup \Delta_i)$ decomposes as

$$\pi_1(V - \bigsqcup \Delta_i) \rightarrow H_1(V - \bigsqcup \Delta_i)/\text{torsion} \cong \mathbb{Z}^m \hookrightarrow H_1(V - \bigsqcup \Delta_i; \mathbb{Z}_{(p)})$$

with the rightmost map injective, by Lemma 2.4(1) and the paragraph below Lemma 2.4. From this it follows that $\mathcal{P}^1\pi_1(V - \bigsqcup \Delta_i) \subset \pi_1(\tilde{V} - \bigsqcup \tilde{\Delta}_i)$.

Suppose that S_j are disjointly embedded surfaces in V satisfying Definition 2.3. By definition and the above observation, we have

$$\pi_1(S_j) \subset \mathcal{P}^n\pi_1(V - \bigsqcup \Delta_i) \subset \mathcal{P}^1\pi_1(V - \bigsqcup \Delta_i) \subset \pi_1(\tilde{V} - \bigsqcup \tilde{\Delta}_i).$$

By the lifting criterion, it follows that the surfaces S_j lift to $\tilde{V} - \bigsqcup \tilde{\Delta}_i$, that is, \tilde{S}_j consists of p^a lifts $\{\Sigma_{j,k}\}_{k=1}^{p^a}$ of S_j . The $\Sigma_{j,k}$ are mutually disjoint, and are disjoint to the slicing disks for \tilde{L} . Furthermore, each $\Sigma_{j,k}$ has self intersection $+1$ in \tilde{V} since so does S_j in V . As subgroups of $\pi_1(V - \bigsqcup \Delta_i)$, we have

$$\pi_1(\Sigma_{j,k}) = \text{a conjugate of } \pi_1(S_j) \subset \mathcal{P}^n\pi_1(V - \bigsqcup \Delta_i) \subset \mathcal{P}^{n-1}\pi_1(\tilde{V} - \bigsqcup \tilde{\Delta}_i).$$

It is easy to see from the definitions that the last inclusion follows from the fact that $\mathcal{P}^1\pi_1(V - \bigsqcup \Delta_i) \subset \pi_1(\tilde{V} - \bigsqcup \tilde{\Delta}_i)$.

It remains to prove that the $\Sigma_{j,k}$ generate $H_2(\tilde{V})/\text{torsion}$. Denote the i^{th} Betti number by $b_i(-; \mathbb{Q}) = \dim_{\mathbb{Q}} H_i(-; \mathbb{Q})$ and $b_i(-; \mathbb{Z}_p) = \dim_{\mathbb{Z}_p} H_i(-; \mathbb{Z}_p)$. We claim that

$$\begin{aligned} b_2(\tilde{V}; \mathbb{Q}) \leq b_2(\tilde{V}; \mathbb{Z}_p) &= b_2(\tilde{V} - \tilde{\Delta}_1; \mathbb{Z}_p) \leq p^a \cdot b_2(V - \Delta_1; \mathbb{Z}_p) \\ &= p^a \cdot b_2(V; \mathbb{Z}_p) = p^a \cdot b_2(V; \mathbb{Q}). \end{aligned}$$

The first inequality is from the universal coefficient theorem. The second part is obtained by a Mayer–Vietoris argument for $(\tilde{V} - \tilde{\Delta}_1) \cup (2\text{-cell}) \simeq \tilde{V}$, using that our previous observation that $H_1(\tilde{V} - \tilde{\Delta}_1; \mathbb{Z}_p) \cong \mathbb{Z}_p$ is generated by $\tilde{\mu}$. The third part follows from Lemma 3.3. The fourth part is again by a Mayer–Vietoris argument as before, for $(V - \Delta_1) \cup (2\text{-cell}) \simeq V$. The last part is shown by Lemma 2.4(2) and its accompanying paragraph; the fact that the torsion part of $H_2(V)$ has order coprime to p .

Now, let h be the map from the free abelian group F generated by the $\Sigma_{j,k}$ into $H_2(\tilde{V})/\text{torsion}$ sending $\Sigma_{j,k}$ to its homology class. The fact that the surfaces $\Sigma_{j,k}$ are disjoint and have self intersection one implies that the composition

$$F \xrightarrow{h} H_2(\tilde{V})/\text{torsion} \xrightarrow{\lambda^{\text{ad}}} \text{Hom}(H_2(\tilde{V})/\text{torsion}, \mathbb{Z}) \xrightarrow{h^*} \text{Hom}(F, \mathbb{Z})$$

is the adjoint of a form represented by the identity matrix, where λ^{ad} is (the adjoint of) the intersection pairing. It follows that the initial map h is injective. Since $b_2(\tilde{V}; \mathbb{Q}) \leq p^a \cdot b_2(V; \mathbb{Q}) = \text{rank } F$, it follows that $b_2(\tilde{V}; \mathbb{Q}) = p^a \cdot b_2(V; \mathbb{Q}) = \text{rank } F$. Since all the terms in the above sequence are free abelian groups of the same rank, it follows that all the maps, particularly h , are isomorphisms. This completes the proof of Theorem 3.2. \square

Remark 3.4 Generalizing Definition 2.3, we can define a relation on links, similarly to [9, Definition 2.1]: for links $L \subset Y$ and $L \subset Y'$ in $\mathbb{Z}_{(p)}$ -homology spheres, we write $L \succeq_{(\mathbb{Z}_{(p)},n)} L'$ if there is a 4-manifold V satisfying the following:

- (1) $H_1(V; \mathbb{Z}_{(p)}) = 0$.
- (2) There exist disjointly embedded annuli C_i in V satisfying $\partial(V, \bigsqcup C_i) = (Y, L) \sqcup -(Y', L')$ and that both $C_i \cap Y, C_i \cap Y'$ are nonempty for each i .
- (3) The intersection pairing on $H_2(V)/\text{torsion}$ is positive-definite and there are disjointly embedded surfaces S_j in $V - \bigsqcup C_i$ which generate $H_2(V)/\text{torsion}$ and satisfy $\pi_1(S_j) \subset \mathcal{P}^n \pi_1(V - \bigsqcup C_i)$.

Note that L is $\mathbb{Z}_{(p)}$ -homology n -positive if and only if $L \succeq_{(\mathbb{Z}_{(p)},n)} (\text{unlink})$. Then the arguments of the proof of Theorem 3.2 show the following generalized statement:

If $L \succeq_{(\mathbb{Z}_{(p)},n)} L'$ and \tilde{L} and \tilde{L}' are height k p -covering links of L and L' obtained by applying the same sequence of operations (C1) and (C2), then $\tilde{L} \succeq_{(\mathbb{Z}_{(p)},n-k)} \tilde{L}'$.

In order to interpret the idea of the same sequence of operations, we use the annuli C_i to pair up components of L and L' .

3.2 Examples: Bing doubles

Theorem 3.2 applied to covering link calculus results for Bing doubles in the literature immediately gives various interesting examples which are often topologically slice links.

We denote by $B(L)$ the Bing double of a link L in S^3 , and for $n \geq 1$ define $B_n(L) = B(B_{n-1}(L))$ to be the n^{th} iterated Bing double, where by convention, $B_0(L)$ is L itself. In this paper Bing doubles are always untwisted. We remark that if K is topologically (resp. smoothly) slice, then $B_n(K)$ is topologically (resp. smoothly) slice. The converse is a well-known open problem.

For an oriented knot K , we denote the reverse of K by K^r .

Theorem 3.5 *If $B_n(K)$ is $\mathbb{Z}_{(p)}$ -homology $(k + 2n - 1)$ -positive (resp. negative, bipolar), then $K \# K^r$ is $\mathbb{Z}_{(p)}$ -homology k -positive (resp. negative, bipolar).*

Proof The following fact is due to Cha–Livingston–Ruberman [7], Cha–Kim [5], Livingston–Van Cott [19] and Van Cott [24]: for any knot K in S^3 and any prime p , $K \# K^r$ is a height $(2n - 1)$ p -covering link of $B_n(K)$. Therefore by Theorem 3.2, the conclusion follows. □

Corollary 3.6 *If $\tau(K) \neq 0$, then $B_n(K)$ is not $\mathbb{Z}_{(p)}$ -homology $(2n - 1)$ -bipolar for any p .*

It is well-known that there are topologically slice knots K with $\tau(K) \neq 0$ (eg $K =$ the positive Whitehead double of any knot J with $\tau(J) > 0$, by Hedden [14]). For such a knot K , Corollary 3.6 implies that $B_n(K)$ is a topologically slice link which is not $(2n - 1)$ -bipolar.

Proof of Corollary 3.6 Suppose $B_n(K)$ is $\mathbb{Z}_{(p)}$ -homology $(2n - 1)$ -positive for some p . Then $K \# K^r$ is $\mathbb{Z}_{(p)}$ -homology 0-positive by Theorem 3.5. It follows that $2\tau(K) = \tau(K \# K^r) \geq 0$ by Theorem 2.7. Similarly, $\tau(K) \leq 0$ if $B_n(K)$ is $\mathbb{Z}_{(p)}$ -homology $(2n - 1)$ -negative. \square

While the non-bipolarity of the above links is easily derived by applying our method, we do not know the precise bipolar height of these links. The following lemma is useful in producing highly bipolar links:

Lemma 3.7 *If L is n -positive (resp. negative, bipolar), then $B_k(L)$ is $(k + n)$ -positive (resp. negative, bipolar). The $\mathbb{Z}_{(p)}$ -homology analogue holds too.*

Proof We may assume $k = 1$ by induction. Let V be an n -positon for $L = K_1 \sqcup \dots \sqcup K_m$ with slicing disks Δ_i . We proceed similarly to the proof of Theorem 2.6(6), except that we need a stronger conclusion. We identify a tubular neighborhood $\nu(\Delta_i)$ with $\Delta_i \times D^2$ as usual. Note that $B(L)$ is obtained by replacing, for all i , $(\nu(K_i), K_i)$ with the standard Bing link L_0 , which is a 2-component link in $S^1 \times D^2$. Viewing L_0 as a link in S^3 via the standard embedding $S^1 \times D^2 \subset \partial(D^2 \times D^2) \cong S^3$, L_0 is a trivial link. Consequently L_0 bounds disjoint slicing disks, say $D_{i,1}$ and $D_{i,2}$, in $D^2 \times D^2 \cong D^4$. Replacing $(\nu(\Delta_i), \Delta_i)$ with $(D^2 \times D^2, D_1 \sqcup D_2)$ for each i , we see that $B(L)$ has slicing disks, say D_ℓ in V . Since $\pi_1(V) = 0$, $\pi_1(V - \bigsqcup \nu(\Delta_i))$ is normally generated by the meridians μ_i of the K_i . Since the meridional curve $* \times S^1 \subset S^1 \times D^2$ is homotopic to a commutator of meridians of the components of L_0 in $S^1 \times D^2 - L_0$, it follows that the image of $\pi_1(V - \bigsqcup \nu(\Delta_i))$ lies in $\pi_1(V - \bigsqcup D_\ell)^{(1)}$. For the surfaces S_j in Definition 2.1, since $\pi_1(S_j) \subset \pi_1(V - \bigsqcup \nu(\Delta_i))^{(n)}$, it follows that $\pi_1(S_j) \subset \pi_1(V - \bigsqcup D_\ell)^{(n+1)}$. This shows that V is an $(n + 1)$ -positon for $B(L)$.

For the $\mathbb{Z}_{(p)}$ -homology analogue, we proceed similarly. In this case, the argument using that $\pi_1(V - \bigsqcup \nu(\Delta_i))$ is normally generated by the meridians does not work. Instead, we appeal to the following: first we claim that the image of $\pi_1(V - \bigsqcup \nu(\Delta_i))$

in $\pi_1(V - \bigsqcup D_\ell)$ lies in the subgroup $\mathcal{P}^1\pi_1(V - \bigsqcup D_\ell)$. For, we have a commutative diagram

$$\begin{array}{ccc}
 \pi_1(V - \bigsqcup v(\Delta_i)) & \longrightarrow & H_1(V - \bigsqcup v(\Delta_i); \mathbb{Z}_{(p)}) \cong (\mathbb{Z}_{(p)})^m \\
 \downarrow & & \downarrow \\
 \pi_1(V - \bigsqcup D_\ell) & \xrightarrow{\psi} & H_1(V - \bigsqcup D_\ell; \mathbb{Z}_{(p)})
 \end{array}$$

with vertical maps induced by the inclusion. Here the isomorphism in the upper right corner is obtained by Lemma 2.4(1). Since $(\mathbb{Z}_{(p)})^m$ is generated by meridians of L which are null-homologous in the exterior of $B(L)$, the right vertical arrow is a zero map. Since $\mathcal{P}^1\pi_1(V - \bigsqcup D_\ell)$ is the kernel of ψ , the claim follows. Now, from the claim we obtain

$$\pi_1(S_j) \subset \mathcal{P}^n\pi_1(V - \bigsqcup v(\Delta_i)) \subset \mathcal{P}^{n+1}\pi_1(V - \bigsqcup D_\ell)$$

as desired. □

Theorem 3.8 *Suppose K is a knot in S^3 which is 0–bipolar and 1–positive but not $\mathbb{Z}_{(p)}$ –homology 1–bipolar for some p . Then $B_n(K)$ is n –bipolar but not $(\mathbb{Z}_{(p)}$ –homology) $2n$ –bipolar.*

For example, we obtain topologically slice links which are n –bipolar but not $2n$ –bipolar, by applying Theorem 3.8 to the knots presented by Cochran and Horn [10]; they constructed topologically slice knots K which are 0–bipolar, 1–positive but not 1–bipolar. Indeed K is shown not to be 1–negative by exhibiting that a certain d –invariant of the double branched cover associated to a metabolizer element is negative in the sense of [9, Theorem 6.2] and Theorem 2.8. It follows that their K is not $\mathbb{Z}_{(2)}$ –homology 1–negative by Theorem 2.8.

Proof of Theorem 3.8 By Lemma 3.7, $B_n(K)$ is n –bipolar since K is 0–bipolar. If $B_n(K)$ is $2n$ –bipolar then it is $\mathbb{Z}_{(p)}$ –homology $2n$ –bipolar for all primes p . By Theorem 3.5 for $k = 1$ we see that $K \# K^r$ is $\mathbb{Z}_{(p)}$ –homology 1–bipolar. Since K is $\mathbb{Z}_{(p)}$ –homology 1–positive, the concordance inverse $-K^r$ of K^r is $\mathbb{Z}_{(p)}$ –homology 1–negative by Theorem 2.6(1), (2). We have that K is concordant to $K \# K^r \# -K^r$. By Theorem 2.6(3), (5), this latter knot is $\mathbb{Z}_{(p)}$ –homology 1–negative since both $K \# K^r$ and $-K^r$ are 1–negative. Therefore so is K by Theorem 2.6(8). This contradicts the hypothesis. □

The examples obtained in [Theorem 3.8](#) illustrate the non-triviality of the n -bipolar filtration for links for higher n . Note that there are still some limitations: the number of components of our link $L = B_n(K)$ grows exponentially on n , and the height $\text{BH}(L) := \max\{h \mid L \text{ is } h\text{-bipolar}\}$ is not precisely determined; we only know that $n \leq \text{BH}(B_n(K)) < 2n$. In the next section we will give examples resolving these limitations.

We finish this section with a discussion of some covering link calculus examples due to A Levine [18]. He considered iterated Bing doubling operations associated to a binary tree T . Namely, for a knot K , $B_T(K)$ is a link with components indexed by the leaf nodes of T , which is defined inductively: for a single node tree T , $B_T(K) = K$. If T' is obtained by attaching two child nodes to a node v of T , then $B_{T'}(K)$ is obtained from $B_T(K)$ by Bing doubling the component associated to v . For a link L , we denote by $\text{Wh}_+(L)$ the link obtained by replacing each component with its positive untwisted Whitehead double. We define the *order* of a binary tree T to be number of non-leaf vertices i.e. one more than the number of trivalent vertices (since the root vertex is bivalent), or equivalently, the number of leaf vertices minus one. We denote the order of T by $o(T)$.

Theorem 3.9 (1) *If $\tau(K) \neq 0$, then $\text{Wh}_+(B_T(K))$ is not $o(T)$ -bipolar.*

(2) *For the Hopf link H , $\text{Wh}_+(B_{T_1, T_2}(H))$ is not $(o(T_1) + o(T_2) + 1)$ -bipolar.*

Proof Levine showed that $\text{Wh}_+(B_T(K))$ has a knot J with $\tau(J) > 0$ as a covering link of height $o(T)$. Similarly for $\text{Wh}_+(B_{T_1, T_2}(H))$, where the relevant covering link has height $o(T_1) + o(T_2) + 1$. \square

4 Raising the bipolar height by one

The goal of this section is to prove the following:

Theorem 4.1 *For any $m > 1$ and $n \geq 0$, there exist topologically slice m -component links in S^3 which are n -bipolar but not $(n + 1)$ -bipolar.*

To construct links satisfying [Theorem 4.1](#), we will introduce an operation that pushes a link into a deeper level of the bipolar filtration. To describe this behaviour of our operation, we will use the following terminology:

Definition 4.2 The *bipolar height* of a link L is defined by

$$\text{BH}(L) := \max\{n \mid L \text{ is } n\text{-bipolar}\}.$$

The $\mathbb{Z}_{(p)}$ -bipolar height is defined by

$$BH^p(L) := \max\{n \mid L \text{ is } \mathbb{Z}_{(p)}\text{-homology } n\text{-bipolar}\}.$$

By convention, $BH(L) = -1$ if L is not 0-bipolar. Similarly for BH^p .

The proof of the following proposition is immediate from the definitions and is left to the reader to check.

Proposition 4.3 For any L and for any p , we have $BH(L) \leq BH^p(L)$.

The following refined notion will be the precise setting for our height-raising theorem.

Definition 4.4 We say that L has property $BH_+^p(n)$ if $BH^p(L) = n$ and L is $\mathbb{Z}_{(p)}$ -homology $(n + 1)$ -positive and we say that L has property $BH_-^p(n)$ if $BH^p(L) = n$ and L is $\mathbb{Z}_{(p)}$ -homology $(n + 1)$ -negative.

Our operation is best described in terms of string links. We always draw a string link horizontally; components of a string link are oriented from left to right, and ordered from bottom to top. We denote the closure of a string link β by $\widehat{\beta}$.

From now on, we assume knots are oriented, so that a knot can be viewed as a 1-component string link and vice versa. (Recall that a 1-component string link is determined by its closure.)

Definition 4.5 (1) For a knot or a 1-string link K , we define $C(K)$ to be the 2-component string link illustrated in Figure 1. The two parallel strands passing through K are untwisted. Note that the closure $\widehat{C(K)}$ is the Bing double of K .

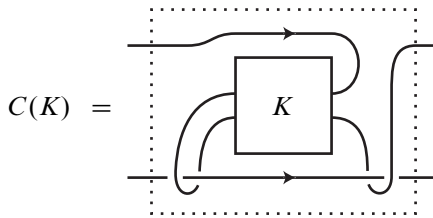

Figure 1: Bing doubling a knot K as a 2-string link

(2) For a 2-component string link β , we define $C(\beta)$ to be the 2-string link shown in Figure 2. (For now ignore the dashed arcs.) As before, we take parallel strands passing through each of the strings of β in an untwisted fashion.

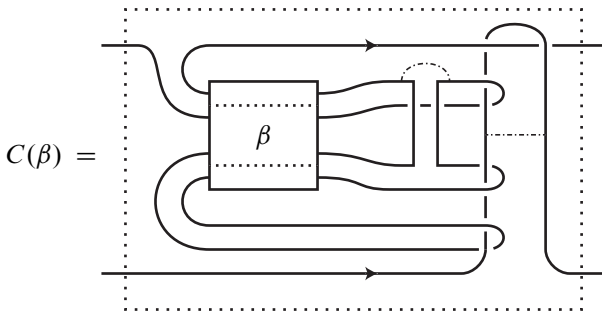

Figure 2: A doubling operation for 2-string links

The key property of the operation $C(-)$ is the following height-raising result:

Theorem 4.6 *Suppose β is a string link with one or two components such that $\widehat{\beta}$ has property $BH_+^p(n)$. Then the link $\widehat{C(\beta)}$ has property $BH_+^p(n + 1)$.*

We remark that the BH_-^p analogue of [Theorem 4.6](#) holds by taking mirror images.

As the first step of the proof of [Theorem 4.6](#), we make a few useful observations as a lemma.

Lemma 4.7 *If $\widehat{\beta}$ is k -positive (resp. negative, bipolar), then $\widehat{C(\beta)}$ is $(k + 1)$ -positive (resp. negative, bipolar). If $\widehat{\beta}$ is $\mathbb{Z}_{(p)}$ -homology k -positive (resp. negative, bipolar), then $\widehat{C(\beta)}$ is $\mathbb{Z}_{(p)}$ -homology $(k + 1)$ -positive (resp. negative, bipolar). If $\widehat{\beta}$ is topologically (resp. smoothly) slice, then so is $\widehat{C(\beta)}$.*

Proof For the case that β is a 1-component string link, this is [Lemma 3.7](#), plus the observation that the Bing double of a slice link is slice, which follows from the argument in the proof of [Theorem 2.6\(6\)](#).

For the 2-component string link case, observe that $\widehat{C(\beta)}$ is obtained from the Bing double $B(\widehat{\beta})$ by band sum of components: two pairs of components are joined. The dashed arcs in [Figure 2](#) indicate where to cut to reverse these band sums. From this the conclusion follows by [Lemma 3.7](#) and [Theorem 2.6\(5\)](#). The sliceness claim is shown similarly: the Bing double of a slice link is slice, as is the internal band sum of a slice link. \square

Due to [Lemma 4.7](#), in order to prove [Theorem 4.6](#) it remains to show, given β for which $\widehat{\beta}$ has property $BH_+^p(n)$, that $\widehat{C(\beta)}$ is not $\mathbb{Z}_{(p)}$ -homology $(n + 2)$ -negative. For this purpose we will use covering link calculus.

In what follows we use the following notation. For two knots J_1 and J_2 , let $\ell(J_1, J_2)$ be the 2–component string link which is the split union of string link representations of J_1 and J_2 , as the first and second components respectively. For a 2–component string link β , we denote by $\tilde{\beta}$ the plat closure of β , see Figure 3, which also indicates the orientation which we give $\tilde{\beta}$. We say that β has unknotted components if each strand of β is unknotted.

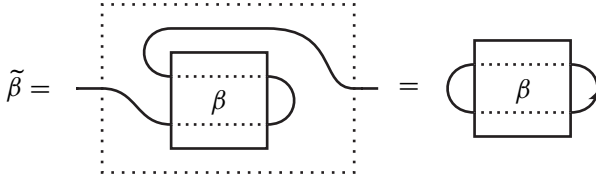

Figure 3: The plat closure of a 2–string links

In what follows, \cdot denotes the product of string links given by concatenation.

Theorem 4.8 For any 2–component string link β with unknotted components, the link $\widehat{C(\beta)}$ has, as a p –covering link of height one, the link $(\beta \cdot \ell(\tilde{\beta}^r, \tilde{\beta}))^\wedge$ in S^3 .

See Figure 4 for the initial link $\widehat{C(\beta)}$, and Figure 5 for its height one covering link $(\beta \cdot \ell(\tilde{\beta}^r, \tilde{\beta}))^\wedge$.

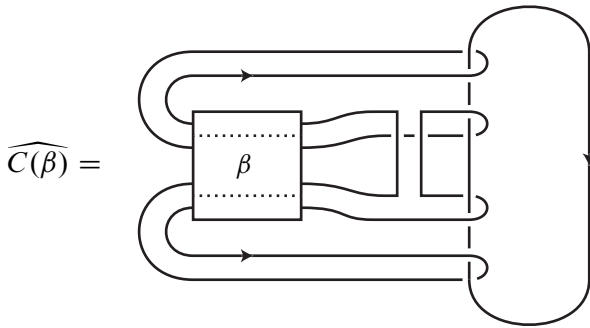

Figure 4: The closure of the 2–string link $C(\beta)$

Proof Our proof mostly consists of pictures. While the statement of Theorem 4.8 is independent of the choice of orientation of links due to our convention (see the remark after Definition 3.1), we will work in the proof with oriented knots and (string) links in order to show clearly how the orientations of involved blocks match. Indeed we will

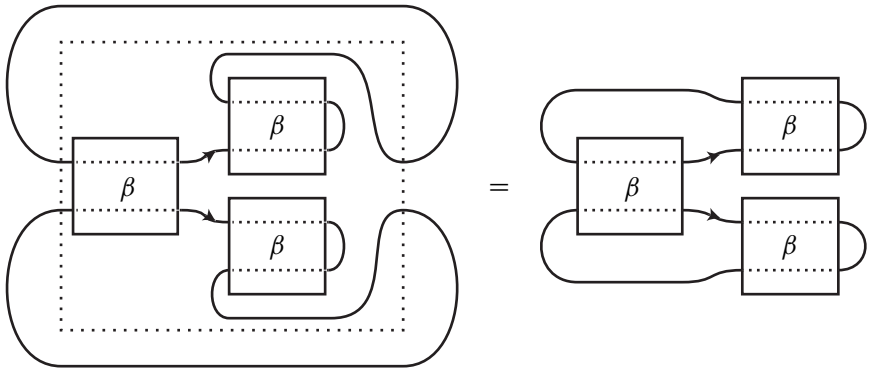

Figure 5: $\widehat{\beta \cdot \ell(\tilde{\beta}^r, \tilde{\beta})}$ is a height one covering link of $\widehat{C(\beta)}$

show that as oriented links the link in Figure 5 with the first (bottom) component’s orientation reversed is a covering link of the link in Figure 4. Choose a such that $p^a \geq 5$ and take the p^a -fold cyclic cover branched along the right hand component of the link $\widehat{C(\beta)}$ illustrated in Figure 4. The covering space is obtained by cutting the 3-sphere along a disk whose boundary is the right hand component, and glueing p^a copies of the result. The covering link (with the pre-image of the branching component forgotten) in the branched cover is shown in Figure 6. Note that the ambient space is again S^3 since the branching component is an unknot.

Forgetting all components except two marked by $*$ in Figure 6, we obtain the 2-component link illustrated in Figure 7, since $p^a \geq 5$. Since β has unknotted components, the link in Figure 7 with the bottom component’s orientation reversed is isotopic to the link $(\beta \cdot \ell(\tilde{\beta}^r, \tilde{\beta}))^\wedge$ which is illustrated in Figure 5. This completes the proof. \square

Now we are ready to give a proof of Theorem 4.6.

Proof of Theorem 4.6 Suppose β is such that $\hat{\beta}$ has property $BH_+^p(n)$. We will show that $\widehat{C(\beta)}$ has property $BH_+^p(n + 1)$. By Lemma 4.7, it suffices to show that $\widehat{C(\beta)}$ is not $\mathbb{Z}_{(p)}$ -homology $(n + 2)$ -bipolar.

When β is a 1-component string link, $\widehat{C(\beta)} = B_1(\hat{\beta})$; that is, the operator C corresponds to Bing doubling. So, if $n = 0$, then Theorem 3.8 (with $n = 1$ in the notation of that theorem) says that $\widehat{C(\beta)}$ is not $\mathbb{Z}_{(p)}$ -homology 2-bipolar. For arbitrary n , observe that the proof of Theorem 3.8 also works if we shift all bipolarity heights by a constant.

Now suppose that β is a 2-component string link. We will show that $\widehat{C(\beta)}$ is not $\mathbb{Z}_{(p)}$ -homology $(n + 2)$ -negative. So let us suppose, for a contradiction, that $\widehat{C(\beta)}$ is $\mathbb{Z}_{(p)}$ -homology $(n + 2)$ -negative.

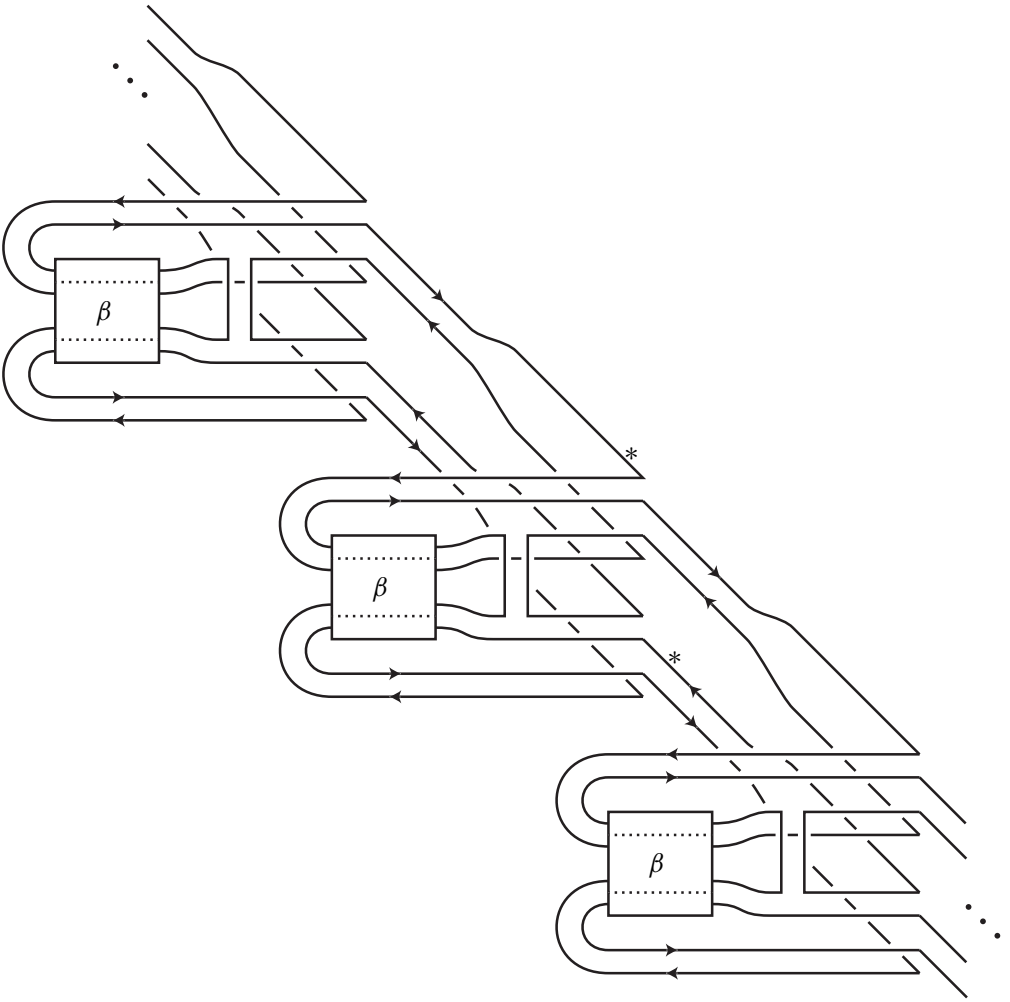

Figure 6: The cyclic branched covering

By [Theorem 4.8](#) and [Theorem 3.2](#), $(\beta \cdot \ell(\tilde{\beta}^r, \tilde{\beta}))^\wedge$ is $\mathbb{Z}_{(p)}$ -homology $(n + 1)$ -negative. Since $\hat{\beta}$ is $\mathbb{Z}_{(p)}$ -homology $(n + 1)$ -positive and $\tilde{\beta}$ and $\tilde{\beta}^r$ are obtained from $\hat{\beta}$ and $\hat{\beta}^r$ by band sum of components, $\tilde{\beta}$ and $\tilde{\beta}^r$ are $\mathbb{Z}_{(p)}$ -homology $(n + 1)$ -positive by [Theorem 2.6\(5\)](#). It follows that $(\ell(\tilde{\beta}^r, \tilde{\beta})^{-1})^\wedge$ is $\mathbb{Z}_{(p)}$ -homology $(n + 1)$ -negative by [Theorem 2.6\(1\)](#), (2) and (3), where for a string link γ , we denote the concordance inverse obtained by mirror image and reversing string orientation by γ^{-1} . Then $\hat{\beta}$, which is concordant to $(\beta \cdot \ell(\tilde{\beta}^r, \tilde{\beta}) \cdot \ell(\tilde{\beta}^r, \tilde{\beta})^{-1})^\wedge$, is $\mathbb{Z}_{(p)}$ -homology $(n + 1)$ -negative by [Theorem 2.6\(5\)](#) and (8). This contradicts the hypothesis that $\hat{\beta}$ has property $\text{BH}_+^p(n)$. Therefore $\widehat{C(\beta)}$ is not $\mathbb{Z}_{(p)}$ -homology $(n + 2)$ -negative, as desired. \square

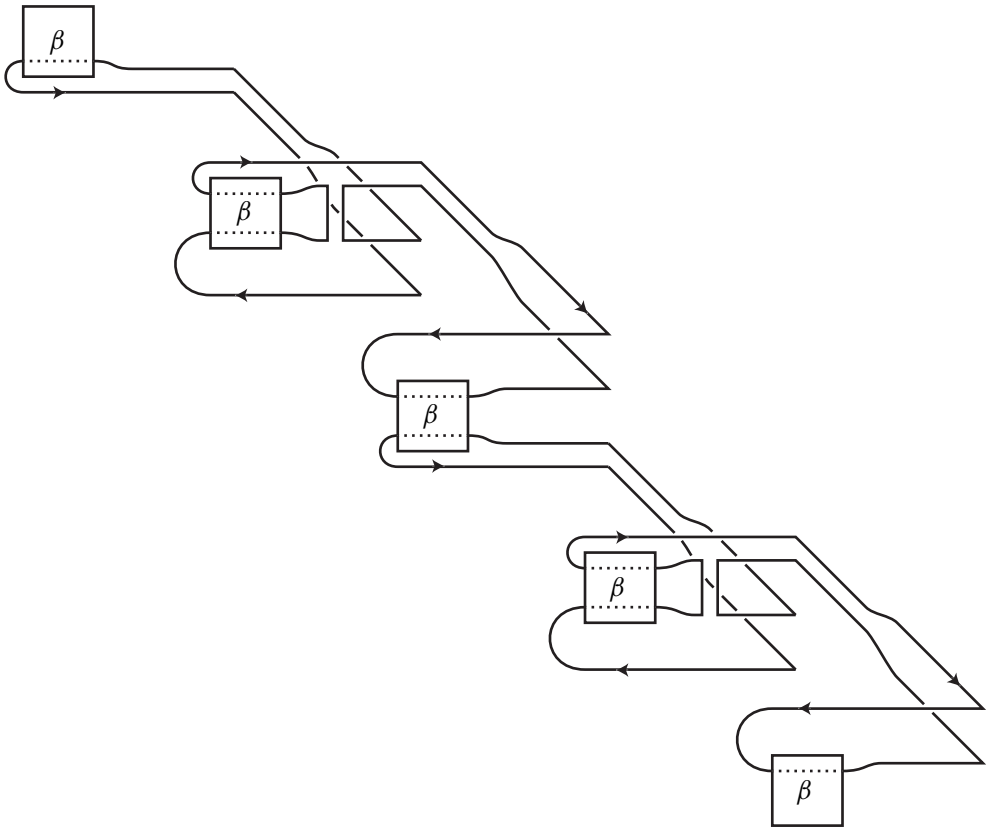

Figure 7: A two-component sublink of Figure 6

We are now ready to prove the promised result (Theorem 4.1) by giving explicit examples. For a knot K , define a sequence $\{C_n(K)\}$ inductively by $C_0(K) := K$, $C_{n+1}(K) := C(C_n(K))$ for $n > 0$. Note that $C_n(K)$ is a 2-component string link for $n > 0$.

Corollary 4.9 Suppose K is a knot which is topologically slice and 0-bipolar and $\mathbb{Z}_{(p)}$ -homology 1-positive but not $\mathbb{Z}_{(p)}$ -homology 1-bipolar for some p . Then the 2-component link $\widehat{C_n(K)}$ is topologically slice and n -bipolar but not $(n + 1)$ -bipolar.

Proof Since K is topologically slice and 0-bipolar, $\widehat{C_n(K)}$ is topologically slice and n -bipolar by applying Lemma 4.7 inductively. So $\text{BH}(\widehat{C_n(K)}) \geq n$. Also, since K has property $\text{BH}_+^p(0)$, $\widehat{C_n(K)}$ has property $\text{BH}_+^p(n)$ by applying Theorem 4.6 inductively. In particular $\text{BH}^p(\widehat{C_n(K)}) = n$, so $\text{BH}(\widehat{C_n(K)}) \leq n$ by Proposition 4.3. Thus $\text{BH}(\widehat{C_n(K)}) = n$ and $\widehat{C_n(K)}$ is n -bipolar but not $(n + 1)$ -bipolar. \square

Using one of the knots of Cochran–Horn [10] for K , as discussed in the paragraph after [Theorem 3.8](#), the 2–component case of [Theorem 4.1](#) follows from [Corollary 4.9](#) with $p = 2$. For the general m –component case, the split union of the 2–component example and an $(m - 2)$ –component unlink is a link with all the desired properties.

5 String links and a subgroup of infinite rank

Thus far, the bipolar filtration of links with $m \geq 2$ components has been a filtration by subsets; the set of links does not have a well defined notion of connected sums. In this section we consider *string links* to impose more structure.

5.1 The bipolar filtration of string links

Although we have already used some standard string link terminology in [Section 4](#), we begin by recalling the definitions of string links and the concordance group of string links, which is our object of study in this section. Readers who are familiar with string links may skip the following three paragraphs.

Fix m distinct interior points in D^2 and identify these with $[m] := \{1, \dots, m\}$. An m –component string link β is a collection of m properly embedded oriented disjoint arcs in $D^2 \times I$ joining $(i, 0)$ to $(i, 1)$, $i \in [m]$. Let β_0 and β_1 be two m –component string links. The *product* $\beta_0 \cdot \beta_1$ is defined by stacking cylinders. We say that β_0 and β_1 are *concordant* if there are m properly embedded disjoint disks in $(D^2 \times I) \times I$ bounded by $(\beta_0 \times 0) \cup ([m] \times \partial I \times I) \cup (-\beta_1 \times 1)$. Concordance classes of string links form a group under the product operation. The identity is the *trivial string link* $[m] \times I \subset D^2 \times I$. The *inverse* β^{-1} of β is defined to be its image under the automorphism $(x, t) \rightarrow (x, 1 - t)$ on $D^2 \times I$. A string link is *slice* if it is concordant to the trivial string link.

The quotient space of $D^2 \times I$ obtained by identifying $D^2 \times 0$ and $D^2 \times 1$ under the identity map and collapsing $x \times I$ to a point for each $x \in \partial D^2$ is diffeomorphic to S^3 . The *closure* $\hat{\beta} \subset S^3$ of β is defined to be the image of β under the quotient map. A string link β is slice if and only if $\hat{\beta}$ is slice as a link. Consequently two string links β_0 and β_1 are concordant if and only if the closure of $\beta_0 \beta_1^{-1}$ is slice as a link. We note that if two string links are concordant then so are their closures, but the converse does not hold in general; for an in-depth study related to this, the readers are referred to [\[13\]](#).

Note that our definitions are also meaningful in the topological category with locally flat submanifolds. In particular the notion of a topologically slice string link is defined.

We say that a string link is n -positive, n -negative or n -bipolar if its closure is, respectively, n -positive, n -negative or n -bipolar. Equivalently, these notions can be defined by asking whether a string link is slice in a 4-manifold V with $\partial V = \partial(D^2 \times I \times I)$, where V should satisfy the properties of [Definition 2.1](#).

As in the introduction, we denote the subgroup of topologically slice n -bipolar string links with m -components by $\mathcal{T}_n^{\text{SL}}(m)$. Note that $\mathcal{T}_n^{\text{SL}}(m)$ is closed under group operations by [Lemma 2.4\(1\), \(2\), \(3\)](#) and [\(5\)](#), since the closure of β^{-1} is $-\widehat{\beta}$ and the closure of $\beta_0\beta_1$ is obtained from $\widehat{\beta}_0 \sqcup \widehat{\beta}_1$ by band sum. Also, $\mathcal{T}_n^{\text{SL}}(m)$ is a normal subgroup since β and a conjugate of β have concordant closures.

This section is devoted to the following special case of [Theorem 1.2](#) in the introduction:

Theorem 5.1 *For any $n \geq 0$ the quotient $\mathcal{T}_n^{\text{SL}}(2)/\mathcal{T}_{n+1}^{\text{SL}}(2)$ contains a subgroup whose abelianization is of infinite rank. For $n \geq 1$, the subgroup is generated by string links with unknotted components.*

For $n = 0$, the theorem follows from the result for knots in [\[10\]](#) by taking the disjoint union of (string link representations of) the Cochran–Horn knots with a trivial strand. [Theorem 1.2](#) for the $m > 2$ component case follows by adjoining the correct number of trivial strands.

5.2 Covering string links

To investigate the group structure of the string link concordance group, we formulate a string link version of the covering link calculus. For this purpose, again similarly to the link case, it is natural to consider string links in a $\mathbb{Z}_{(p)}$ -homology $D^2 \times I$, which we will call $\mathbb{Z}_{(p)}$ -string links. Here a 3-manifold Y is said to be a $\mathbb{Z}_{(p)}$ -homology $D^2 \times I$ if $H_*(Y; \mathbb{Z}_{(p)}) \cong H_*(D^2 \times I; \mathbb{Z}_{(p)})$ and the boundary ∂Y is identified with $\partial(D^2 \times I)$. The boundary identification enables us to define product, closure and $\mathbb{Z}_{(p)}$ -homology concordance of $\mathbb{Z}_{(p)}$ -string links. In addition, we define the \mathbb{Q}/\mathbb{Z} -valued self-linking number of a component of a $\mathbb{Z}_{(p)}$ -string link to be that of the corresponding component of the closure. We remark that all $\mathbb{Z}_{(p)}$ -string links considered in this section have components with vanishing \mathbb{Q}/\mathbb{Z} -valued self-linking.

A string link is defined to be $\mathbb{Z}_{(p)}$ -homology n -positive, n -negative or n -bipolar if its closure is $\mathbb{Z}_{(p)}$ -homology n -positive, n -negative or n -bipolar, respectively. The definitions of the bipolar heights $\text{BH}(\beta)$ and $\text{BH}^p(\beta)$ carry over verbatim from the ordinary link case.

For a $\mathbb{Z}_{(p)}$ -string link β , we consider the following operations: (CL1) taking a sublink of β , and (CL2) taking the pre-image of β in the p^a -fold cyclic cover of the ambient

space branched along a component of β with vanishing \mathbb{Q}/\mathbb{Z} -valued self-linking. The result can always be viewed as a $\mathbb{Z}_{(p)}$ -string link; for this purpose we fix, in (CL2), an identification of the p^a -fold cyclic branched cover of $(D^2, [m])$ branched along $i \in [m]$ with $(D^2, [p^a(m - 1) + 1])$.

Definition 5.2 A string link obtained from β by a finite sequence of (CL1) and/or (CL2) is called a p -covering string link of β of height $\leq h$ (or of height h as an abuse of terminology), where h is the number of (CL2) operations.

The following immediate consequence of the definitions will be useful. Note that a fixed sequence of operations (CL1) and (CL2) starting from an m -component string link gives rise to a covering string link of any m -component string link, which we refer to as a *corresponding* covering string link.

Lemma 5.3 *The product operation of string links commutes with covering string link operations. In other words, a covering string link of a product is the product of the corresponding covering string links.*

Essentially, Lemma 5.3 says that the covering string link operation induces a *homomorphism* of the string link concordance groups.

5.3 Computation for string link examples

To show Theorem 5.1 we consider the subgroup generated by the 2-component string links $C_n(K_i)$, constructed in Section 4, where K_i are the knots used to prove [10, Theorem 1.1]. Indeed, for most of the proof it suffices to assume that the K_i are knots which are topologically slice, 0-bipolar and 1-positive. The exception to this is that in the last part of Section 5.4 we need the K_i to also satisfy a technical condition on certain d -invariants of double covers, which was shown in [10] (see Proposition 5.7). As before we often regard a knot as a string link with one component and vice versa.

A typical element in the subgroup generated by the $C_n(K_i)$ is of the form $\prod_{j=1}^s C_n(K_{i_j})^{\epsilon_j}$, where $\epsilon_j = \pm 1$.

Lemma 5.4 *The string link $\prod_{j=1}^s C_n(K_{i_j})^{\epsilon_j}$ has $BH \geq n$, $BH^p \geq n$ for any prime p and is topologically slice.*

Proof Each factor string link $C_n(K_{i_j})^{\epsilon_j}$ has closure which is n -bipolar, by Lemma 4.7. If $\epsilon_j = -1$ then this still holds by Theorem 2.6(1) and (2). The closure of the product of the $C_n(K_{i_j})^{\epsilon_j}$ is a band sum of the closures of the $C_n(K_{i_j})^{\epsilon_j}$. The latter link is n -bipolar by Theorem 2.6(5).

Similarly, $\prod_{j=1}^s C_n(K_{i_j})^{\epsilon_j}$ is topologically slice and $\mathbb{Z}_{(p)}$ -homology n -bipolar. \square

The remaining part of this section is devoted to showing that the subgroup generated by the $C_n(K_i)$ has infinite rank abelianization. It turns out that for this purpose we need a more complicated application of the covering link calculus than we used in Section 4. In fact this is related to the orientation reversing which was performed in the last paragraph of the proof of Theorem 4.8. This is not allowed for string links if we want our covering links to respect the product structure, as in Lemma 5.3.

To describe our covering string link calculation, we use the following notation. For a string link β , define $r(\beta)$ to be β with reversed string orientation, and define $r_s(\beta) = r(\dots(r(\beta))\dots)$ where r is applied s times. Note that $r_s(\beta) = \beta$ if s is even, whereas $r_s(\beta) = r(\beta)$ if s is odd. Define $T(\beta)$ to be the string link shown in Figure 8, and $T_s(\beta) = T(\dots(T(\beta))\dots)$, where T is applied s times. For a 1–component string link α , let $\ell_2(\alpha) = \ell(\alpha, \alpha)$ be the split union of two copies of α , which is viewed as a 2–component string link. Recall from Section 4 that $\tilde{\beta}$ is the 1–component string link shown in Figure 3. Define $N_d(J)$ to be the d –fold cyclic branched cover of a knot J . We denote $N_d(\hat{\alpha})$ by $N_d(\alpha)$ for a 1–component string link α , viewing α as a knot. Given a string link β in Y and another 3–manifold N , remove a 3–ball from Y which is disjoint to β . Filling in this 3–ball with a punctured N , we obtain a new string link in $Y \# N$. We call the result of this construction “ β in the Y summand of $Y \# N$ ”.

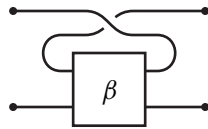

Figure 8: The string link $T(\beta)$

Theorem 5.5 *Suppose β is a 2–component string link with unknotted components. Then the string link $T_s(r_t(C(\beta))) \cdot \ell_2(\alpha)$ has, as a p –covering string link of height one, the string link $T_{2s+1}(r_{s+t+1}(\beta)) \cdot \ell_2(r_{s+t}(\tilde{\beta})) \cdot \alpha$ in the $D^2 \times I$ summand of $(D^2 \times I) \# N_{p^a}(\alpha)$.*

See Figures 9 and 10 for the base and covering string links in Theorem 5.5 for $t = 0$. Here, \boxed{s} represents s left-handed half twistings (i.e. s positive crossings) arranged vertically, which are obtained by applying T_s .

Proof of Theorem 5.5 We will give a proof for $t = 0$ only, since exactly the same argument shows the $t = 1$ case; only the residue of t modulo 2 matters. By choosing a such that $p^a \geq 5$ and taking the p^a –fold cyclic branched cover of $D^2 \times I$ along the

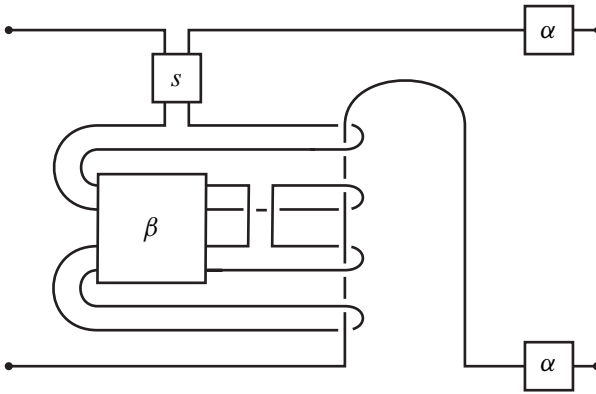

Figure 9: The string link $T_s(C(\beta)) \cdot \ell_2(\alpha)$

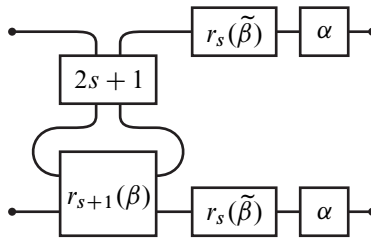

Figure 10: The string link $T_{2s+1}(r_{s+1}(\beta)) \cdot \ell_2(r_s(\tilde{\beta})) \cdot \alpha$

first (bottom) component of the link in Figure 9, we obtain a p -covering link which is similar to that shown in Figure 6. By taking a sublink similar to the sublink which was taken to pass from Figure 6 to Figure 7, we obtain the covering string link shown in Figure 11, which is in the $D^2 \times I$ summand of $(D^2 \times I) \# N_{p^a}(\alpha)$.

After an isotopy, we obtain the string link in Figure 12. We use that a single component of β is unknotted, so that the upper left and lower right occurrences of β in Figure 11 are removed.

Then a further isotopy gives us Figure 13. Here the upper component in Figure 12 corresponds to the upper component of Figure 13. Using the fact that a local knot on a component of a string link can be moved to anywhere on the same component, we see that the upper left β in Figure 12 becomes the upper $r_s(\tilde{\beta})$ part in Figure 13. The lower component is simplified similarly but an additional half twist is introduced.

Finally, by moving the box β down, across the $s + 1$ half twists, we obtain the desired covering string link $T_{2s+1}(r_{s+1}(\beta)) \cdot \ell_2(r_s(\tilde{\beta})) \cdot \alpha$ illustrated in Figure 10. \square

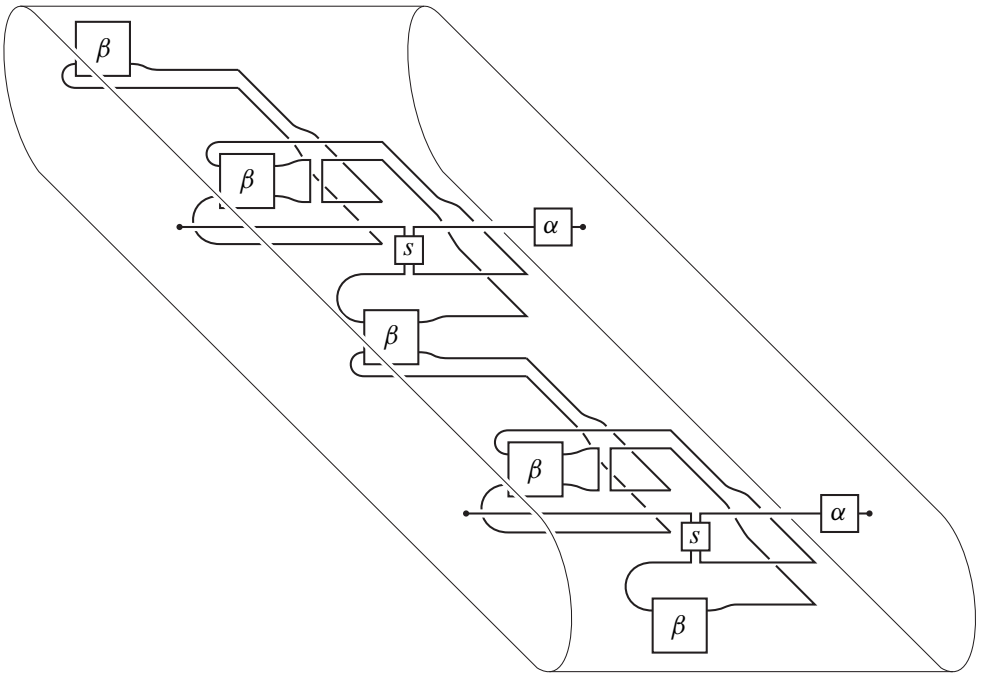

Figure 11: A covering string link of Figure 9, drawn in $D^2 \times I$

Corollary 5.6 For any 1–component string link γ , the 2–component string link $C_n(\gamma)$ has, as a p –covering string link of height n , the 1–component string link $\gamma \cdot r(\gamma) \cdot \widetilde{C_1(\gamma)} \cdots \widetilde{C_{n-1}(\gamma)}$ in the $D^2 \times I$ summand of the connected sum of $D^2 \times I$ and $\mathbb{Z}_{(p)}$ –homology spheres of the form $N_{p^a}(\widetilde{C_k(\gamma)})$ where either $2 \leq k \leq n - 1$ or $(k, p^a) = (1, p)$.

Proof By repeated application of Theorem 5.5 starting with $C_n(\gamma)$, we obtain

$$T_1(r(C_{n-1}(\gamma))) \ell_2(\widetilde{C_{n-1}(\gamma)}), \quad T_3(r(C_{n-1}(\gamma))) \ell_2(\widetilde{C_{n-2}(\gamma)} \widetilde{C_{n-1}(\gamma)}), \dots, \\ T_{2^{n-1-1}}(r(C_1(\gamma))) \ell_2(\widetilde{C_1(\gamma)} \cdots \widetilde{C_{n-1}(\gamma)})$$

as covering string links of $C_n(\gamma)$. The last covering string link in the above list has height $n - 1$ and is in the $D^2 \times I$ summand of $(D^2 \times I) \# N$, where N is a connected sum of $\mathbb{Z}_{(p)}$ –homology spheres of the form $N_{p^a}(\widetilde{C_k(\gamma)})$ with $2 \leq k \leq n - 1$. This covering string link is shown in Figure 14.

As the final covering, we proceed similarly to [7, Section 3]. By taking the p –fold cover branched along the bottom component of the link in Figure 14 and then taking a component, we obtain the string link illustrated in Figure 15, which is in the $D^2 \times I$

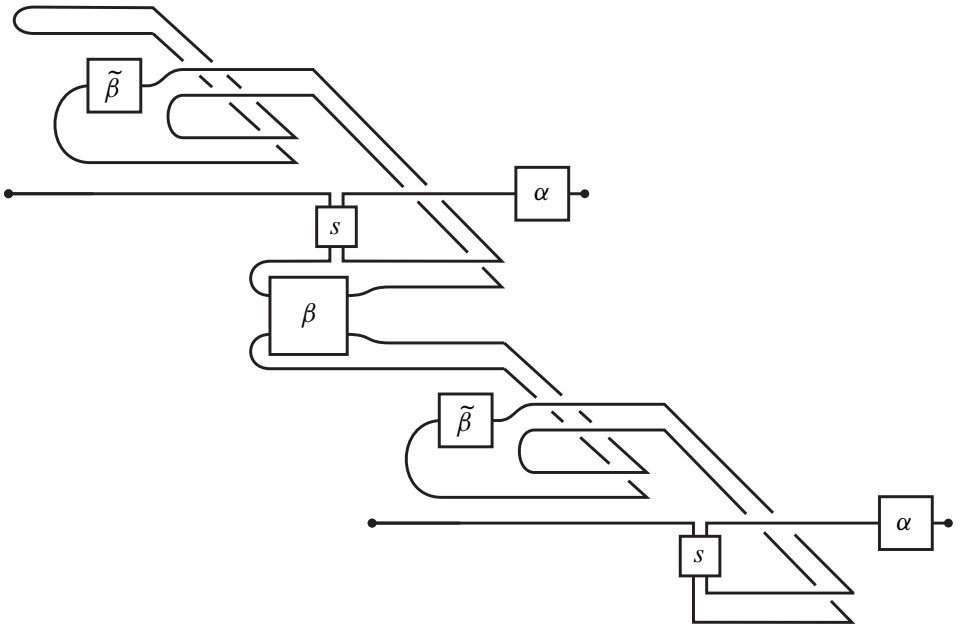

Figure 12: A simplified version of Figure 11

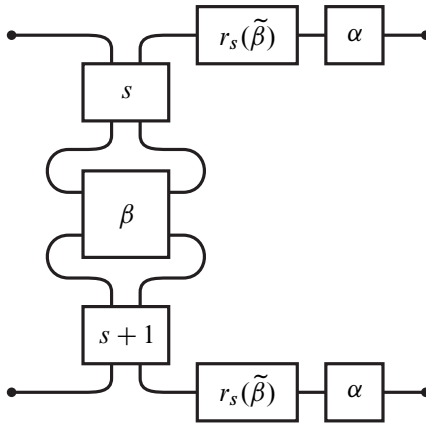

Figure 13: A planar version of Figure 12

summand of $(D^2 \times I) \# N_1$, where N_1 is a connected sum of $\mathbb{Z}_{(p)}$ -homology spheres of the form $N_{p^a}(\widehat{C_k}(\gamma))$ for either $2 \leq k \leq n - 1$ or $(k, p^a) = (1, p)$. Note that this can be done even for $p = 2$; the final covering does not require us to take a covering of order $p^a \geq 5$. It is easily seen that the link in Figure 15 is isotopic to $\gamma \cdot r(\gamma) \cdot \widehat{C_1}(\gamma) \cdots \widehat{C_{n-1}}(\gamma)$ as desired. \square

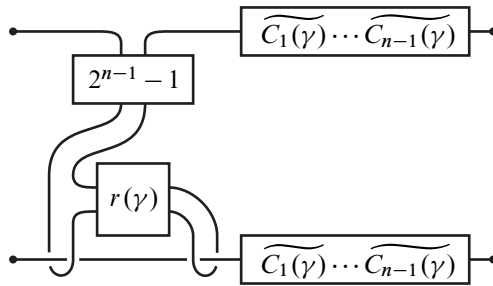

Figure 14: A height $n - 1$ covering string link of $C_n(\gamma)$

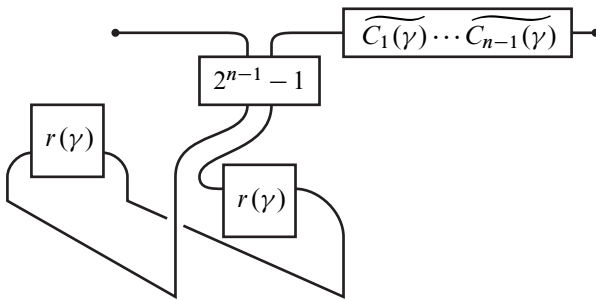

Figure 15: A height n covering string link of $C_n(\gamma)$

5.4 Proof of Theorem 5.1

We are now ready to prove [Theorem 5.1](#). As before, consider the 2–component string link $\beta = \prod_{j=1}^s C_n(K_{i_j})^{\varepsilon_j}$ where the K_i are the knots in [\[10\]](#). We have that β is n –bipolar and topologically slice by [Lemma 5.4](#). Therefore, it suffices to show the following: define $a_i := \sum_{\{j|i_j=i\}} \varepsilon_j$. Suppose $a_i \neq 0$ for some i . Then β is not $\mathbb{Z}_{(p)}$ –homology $(n + 1)$ –bipolar.

In this proof we will work with a general prime p for as long as possible, although at the end of the proof we will specialize to $p = 2$. The specialization occurs due to the fact that we need to use d –invariant calculations which were made for double covers of knots, by [Manolescu–Owens \[20\]](#) and [Cochran–Horn \[10\]](#).

By replacing β with β^{-1} and reindexing the knots K_i if necessary, we may assume that $a_1 > 0$. Suppose for a contradiction that β is $\mathbb{Z}_{(p)}$ –homology $(n + 1)$ –negative. Applying [Theorem 3.2](#), we see that the knot

$$\#_{j=1}^s \varepsilon_j \left(K_{i_j} \# K_{i_j}^r \# \left(\#_{k=1}^{n-1} \overline{C_k(K_{i_j})} \right) \right)$$

is $\mathbb{Z}_{(p)}$ -homology 1-negative, since it is the closure of a height n covering string link of β by Corollary 5.6 and Lemma 5.3. Here, by the description of the ambient space of our covering links in Corollary 5.6, the knot lies in a 3-ball in the connected sum, say N , of 3-manifolds of the form $N_{p^a}(\varepsilon_j \widehat{C}_k(K_{i_j}))$, where either $k \geq 2$ or $(k, p^a) = (1, p)$; we note that the exponent a need not be the same for different summands.

Recall that K_{i_j} is 0-bipolar. So $C_k(K_{i_j})^{\varepsilon_j}$ is 2-bipolar for $k \geq 2$ by Lemma 4.7. Since the plat closure $(-)\widetilde{\sim}$ is obtained from the closure $(-)\widehat{\sim}$ by band sum of components, $\varepsilon_j \widehat{C}_k(K_{i_j})$ is 2-bipolar for $k \geq 2$ by Theorem 2.6(5). Similarly $\varepsilon_j \widehat{C}_1(K_{i_j})$ is 1-bipolar. Therefore $-\varepsilon_j \widehat{C}_k(K_{i_j})$ is 1-negative for $k \geq 1$. By Theorem 2.6(5), we have that the knot

$$\#_{j=1}^s \varepsilon_j \left(K_{i_j} \# K_{i_j}^r \# \left(\#_{k=1}^{n-1} \widehat{C}_k(K_{i_j}) \# -\widehat{C}_k(K_{i_j}) \right) \right),$$

which is again in a 3-ball in N , is $\mathbb{Z}_{(p)}$ -homology 1-negative. By Theorem 2.6(8), the knot

$$\#_{j=1}^s \varepsilon_j (K_{i_j} \# K_{i_j}^r),$$

which is in a 3-ball in N , is $\mathbb{Z}_{(p)}$ -homology 1-negative. Since the connected sum operation is commutative, the knot

$$J := \#_i a_i (K_i \# K_i^r)$$

lying in a 3-ball in N is $\mathbb{Z}_{(p)}$ -homology 1-negative.

We will remove many summands from the ambient space N of J , without altering the $\mathbb{Z}_{(p)}$ -homology 1-negativity. First let V be a $\mathbb{Z}_{(p)}$ -homology 1-negaton for J . For $k \geq 2$, we will remove all the $N_{p^a}(\varepsilon_j \widehat{C}_k(K_{i_j}))$ summands. Recall that $\varepsilon_j \widehat{C}_k(K_{i_j})$ is 2-bipolar for $k \geq 2$. By Theorem 3.2, the branched cover $N_{p^a}(\varepsilon_j \widehat{C}_k(K_{i_j}))$ bounds a $\mathbb{Z}_{(p)}$ -homology 1-positon, say V_{i_j} . View ∂V as the union of a (many) punctured S^3 and a disjoint union of punctured $N_{p^a}(\varepsilon_j \widehat{C}_k(K_{i_j}))$ glued along the boundary. Viewing each V_{i_j} as a (relative to the boundary) cobordism from a punctured $N_{p^a}(\varepsilon_j \widehat{C}_k(K_{i_j}))$ to B^3 , and attaching each $-V_{i_j}$ to V along the punctured

$$N_{p^a}(\varepsilon_j \widehat{C}_k(K_{i_j})) \quad \text{for } k \geq 2,$$

we obtain a 4-manifold W whose boundary is a connected sum, say N' , of 3-manifolds of the form $N_p(\varepsilon_j \widehat{C}_1(K_{i_j}))$. Moreover, W is a $\mathbb{Z}_{(p)}$ -homology 1-negaton for the knot J which is now considered as a knot in N' . This can be seen by an easy

Mayer–Vietoris argument which shows that

$$H_2(W)/\text{torsion} \cong (H_2(V)/\text{torsion}) \oplus \left(\bigoplus H_2(V_{i_j})/\text{torsion} \right),$$

and by observing that the change in orientation of the V_{i_j} causes their intersection forms to be negative definite.

The argument above for removing the $N_{p^a}(\varepsilon_j \widetilde{C_k(K_{i_j})})$ summands for $k \geq 2$ also works in the case $k = 1$, when $\varepsilon_j = 1$, since K_{i_j} is 1–positive and so $\widetilde{C_1(K_{i_j})}$ is 2–positive. So we can in fact assume that J is a $\mathbb{Z}_{(p)}$ –homology 1–negative knot in a 3–ball in a connected sum of 3–manifolds of the form $N_p(-C_1(K_{i_j}))$.

Furthermore, since $a_1 > 0$ and K_1 is 1–positive by our assumption, it follows that

$$J' = K_1 \# \left(\#_{i \neq 1} a_i (K_i \# K_i^r) \right)$$

which is in the same ambient space is $\mathbb{Z}_{(p)}$ –homology 1–negative.

We will derive a contradiction by using d –invariants. We remark that we essentially follow the argument in [10, Section 4, Proof of Theorem 1.1], with additional complication required to resolve the difficulty from the remaining 3–manifold summands in the ambient space of J' .

From now on we restrict to $p = 2$. Let Σ be the double branched cover of J' . It is easily seen that Σ is the connected sum of $N_2(K_1)$, $a_i N_2(K_i \# K_i^r)$ with $i \neq 1$, and additional summands of the form

$$N_2(-\widetilde{C_1(K_{i_j}^r)}).$$

By combining Figures 1 and 3, observe that the knot $-\widetilde{C_1(K_{i_j}^r)}$ is the Whitehead double of $-K_{i_j}^r$ with positive clasp. So $N_2(-\widetilde{C_1(K_{i_j}^r)})$ is a homology sphere. It follows that $N_2(-\widetilde{C_1(K_{i_j}^r)})$ has a unique spin^c –structure, and the spin^c –structures of

$$Y := N_2(K_1) \# \left(\#_{i \neq 1} a_i N_2(K_i \# K_i^r) \right)$$

are in 1–1 correspondence with those of Σ . We need the following fact concerning the knots K_i :

Proposition 5.7 [10, Section 4, proof of Theorem 1.1] *There is a spin^c –structure \mathfrak{s} on Y such that $d(Y, \mathfrak{s}) < 0$ and the corresponding first homology class lies in any metabolizer.*

In our case, the corresponding spin^c -structure \mathfrak{t} of Σ also represent a homology class lying in any metabolizer, and we have $d(\Sigma, \mathfrak{t}) = d(Y, \mathfrak{s}) + \sum_{\ell} d(Y_{\ell})$ where the Y_{ℓ} denote the $N_2(-\overline{C_1(K_{i_j}^r)})$ summands and $d(Y_{\ell})$ denotes the d -invariant associated to the unique spin^c -structure. By [20, Theorem 1.5], $d(Y_{\ell}) \leq 0$ since $-\overline{C_1(K_{i_j}^r)}$ is a positive Whitehead double. It follows that $d(\Sigma, \mathfrak{t}) < 0$. By the $\mathbb{Z}_{(2)}$ -homology 1-negative version of Theorem 2.8, this contradicts that J' is $\mathbb{Z}_{(2)}$ -homology 1-negative. \square

Appendix A: Signature invariants and 0-positivity of knots in $\mathbb{Z}_{(p)}$ -homology spheres

In this appendix we give a proof that the signature invariant of knots in rational homology spheres defined in [6] gives an obstruction to $\mathbb{Z}_{(p)}$ -homology 0-positivity. This is a generalization of [9, Proposition 4.1]

We begin by describing the invariant following [6]. Suppose K is a knot in a rational homology 3-sphere Y . A surface F embedded in Y is called a *generalized Seifert surface* for K if for some $c \neq 0$, F is bounded by the union of c parallel copies of K which are taken along a framing on K which agrees with the framing induced by F on each parallel copy. The integer c is called the *complexity* of F . See Lemma 2.5 and the preceding discussion on zero-framings of knots in rational homology spheres. A Seifert matrix A is defined as usual: choosing a basis $\{x_i\}$ of $H_1(F)$, $A = (\text{lk}_Y(x_i^+, x_j))_{ij}$ where x_i^+ is obtained by pushing x_i slightly along the positive normal direction of F . Note that here the linking number lk_Y is rational-valued. Define, for $\theta \in \mathbb{R}$,

$$\sigma_A(\theta) = \text{sign}((1 - e^{2\pi i\theta})A + (1 - e^{-2\pi i\theta})A^T)$$

and let

$$\bar{\sigma}_A(\theta) = \frac{1}{2} \left(\lim_{\phi \rightarrow \theta_-} \sigma_A(\phi) + \lim_{\phi \rightarrow \theta_+} \sigma_A(\phi) \right)$$

be the average of the one-sided limits. Now the *signature average function* for K is defined by $\bar{\sigma}_K(\theta) = \bar{\sigma}_A(\theta/c)$, where c is the complexity of the generalized Seifert surface F . Due to [6], the function $\bar{\sigma}_K: \mathbb{R} \rightarrow \mathbb{Z}$ is invariant under a concordance in a rational homology $S^3 \times I$.¹ For knots in S^3 , $\bar{\sigma}_K$ is equal to the Levine–Tristram signature.

Theorem A.1 *If K is $\mathbb{Z}_{(p)}$ -homology 0-positive, then $\bar{\sigma}_K(\theta) \leq 0$ for any $\theta \in \mathbb{R}$.*

¹In [6], they consider the jump at θ , rather than the average, as a concordance invariant. It is easy to see that the average function determines the jump function and vice versa.

Proof First note that $\bar{\sigma}_K$ is defined by Lemma 2.5. Suppose V is a $\mathbb{Z}_{(p)}$ -homology 0–positon for an $K \subset Y$, with slicing disk Δ . Choose a generalized Seifert surface F for K , and let A be the Seifert matrix. It suffices to show that $\sigma_A(\theta) \leq 0$ on a dense subset of \mathbb{R} . By using the observation in [6, page 1178] that the Seifert pairing vanishes at (x, y) whenever either x or y is a boundary component of F , it can be seen that the Seifert matrix of A is S -equivalent to the Seifert matrix of a new surface obtained by attaching half-twisted bands to the boundary of F in such a way that the new boundary is the $(n, 1)$ -cable of K . Since the $(n, 1)$ -cable of K is $\mathbb{Z}_{(p)}$ -homology 0–positive by Theorem 2.6(6), we may assume that $\partial F = K$.

We will use the following fact: consider a rational homology 3–sphere Σ and a framed knot J in Σ . Suppose (W, M) is a $(4, 2)$ -manifold pair with M framed (i.e. we identify $\nu(M)$ with $M \times D^2$), such that (Σ, J) is a component of $\partial(W, M)$, $\tilde{H}_*(\partial W; \mathbb{Q}) = 0$, and (W, M) is primitive in the sense of [6, page 1170], that is, there is a homomorphism $H_1(W - M) \rightarrow \mathbb{Z}$ whose restriction on the circle bundle of M coincides with $H_1(M \times S^1) \rightarrow H_1(S^1) = \mathbb{Z}$ induced by the projection. Let \tilde{W} be the d -fold cyclic branched cover of W along M , and $t: \tilde{W} \rightarrow \tilde{W}$ be the generator of the covering transformation group corresponding to the (positive) meridian of J . Let $\sigma_{k,d}(W, M)$ be the signature of the restriction of the intersection pairing on the $e^{2\pi i k/d}$ -eigenspace of $t_*: H_2(\tilde{W}; \mathbb{C}) \rightarrow H_2(\tilde{W}; \mathbb{C})$.

Lemma A.2 *The value $\sigma_{k,d}(W, M) - \text{sign}(W)$ is determined by (Σ, J) , independently of the choice of (W, M) .*

Some special cases of Lemma A.2, at least, seem to be folklore in the classical signature theory (eg, see [25, Theorem 4.4] for the case of $W = \Sigma \times I$). The above general case is essentially proven by an argument of [6, Lemma 4.2], although [6, Lemma 4.2] is stated with a slightly stronger hypothesis to eliminate the $\text{sign}(W)$ term. For the reader's convenience we will give a proof later.

Let $F' \subset Y \times I$ be the framed surface obtained by pushing the interior of $F \subset Y = Y \times 0$ slightly into $Y \times (0, 1)$. In [6, Lemma 4.3], it was shown that $\sigma_A(k/d) = \sigma_{k,d}(Y \times I, F')$. Since $\text{sign}(Y \times I) = 0$, it follows that $\sigma_A(k/d) = \sigma_{k,d}(V, \Delta) - \text{sign}(V)$ by Lemma A.2.

The remaining part of the proof is now almost identical with that of [9, Proposition 4.1]. Since V has positive definite intersection form, $\text{sign}(V) = b_2(V)$. Using the observations given above, the eigenspace-refined Euler characteristic argument of the last part of the proof of [9, Proposition 4.1] is carried out to show that $\sigma_{k,d}(V, \Delta) \leq b_2(V)$ whenever $d \nmid k$. Therefore $\sigma_A(k/d) \leq 0$ for $d \nmid k$. Since such k/d form a dense subset of \mathbb{R} , the proof is completed. \square

Proof of Lemma A.2 Suppose both (W, M) and (W', M') are as in the description above the statement of Lemma A.2. We consider the pair $(X, E) = (W, M) \cup_{(\Sigma, \mathcal{J})} -(W', M')$. We identify the normal bundle of E with $E \times D^2$ under the framing of E . By the assumption there is a map $X - E \rightarrow S^1$ which restricts to the projection $E \times S^1 \rightarrow S^1$ on the circle bundle associated to the normal bundle of E . We may assume that it restricts to a constant map on ∂X , since $H_1(\partial X)$ is torsion. Extend it to $f: X = X \times 0 \rightarrow D^2$ by glueing the projection $E \times D^2 \rightarrow D^2$, and extend f to $g: U = X \times I \rightarrow D^2$ in such a way that the restriction of g on $(\partial X \times I) \cup_{\partial X \times 1} (X \times 1)$ is a constant map away from $0 \in D^2$. We may assume g is smooth and $0 \in D^2$ is a regular value. Now $N = g^{-1}(0)$ is a submanifold in U satisfying

$$\partial(U, N) = (X \times 0, E) \cup (\partial X \times I, \emptyset) \cup (X \times 1, \emptyset).$$

It follows that $\sigma_{k,d}(X, E) + \sigma_{k,d}(\partial X \times I, \emptyset) = \sigma_{k,d}(X, \emptyset)$. It is well known that $\sigma_{k,d}(X, \emptyset) = \text{sign}(X)$, namely, the eigenspace refined signature of the d -fold covering associated to the zero map $\pi_1(-) \rightarrow \mathbb{Z}_d$ is equal to the ordinary signature. We also have $\sigma_{k,d}(\partial X \times I, \emptyset) = \text{sign}(\partial X \times I) = 0$, where the last equality holds since $\partial X \times I$ is a product. By combining the above with Novikov additivity, it follows that

$$\sigma_{k,d}(W, M) - \sigma_{k,d}(W', M') = \sigma_{k,d}(X, E) = \text{sign}(X) = \text{sign}(W) - \text{sign}(W'). \quad \square$$

Appendix B: Amenable von Neumann ρ -invariants and n -positivity

In this appendix we discuss the relationship between amenable von Neumann ρ -invariants and $\mathbb{Z}_{(p)}$ -homology n -positivity.

Theorem B.1 *Suppose a knot K has a $\mathbb{Z}_{(p)}$ -homology n -positon V with slicing disk Δ . Let $M(K)$ be the zero-surgery manifold of K . If $\phi: \pi_1(M(K)) \rightarrow \Gamma$ is a homomorphism into an amenable group Γ lying in Strebel’s class $D(\mathbb{Z}_p)$ that sends a meridian of K to an infinite order element and extends to $\psi: \pi_1(V - \Delta) \rightarrow \Gamma$, then the von Neumann invariant $\rho^{(2)}(M(K), \phi)$ is nonpositive. In addition, if $\psi(\mathcal{P}^n \pi_1(V - \Delta)) = \{e\}$ (for example when $\mathcal{P}^n \Gamma = \{e\}$), then $\rho^{(2)}(M(K), \phi) = 0$.*

Our proof is a combination of the idea of its homotopy n -positive analogue (see [9, Theorem 5.8]) and the technique for amenable L^2 -invariants in [2].

Proof Consider $W_0 = V - \nu(D)$, whose boundary is $M(K)$. Let $\rho^{(2)}(M(K), \phi)$ be the invariant given by (or defined to be) the L^2 -signature defect $\text{sign}_{\Gamma}^{(2)}(W_0) - \text{sign}(W)$, where $\text{sign}_{\Gamma}^{(2)}(W_0)$ is the L^2 -signature of the intersection pairing defined

on $H_2(W_0; \mathcal{N}\Gamma)$ and $\mathcal{N}\Gamma$ is the group von Neumann algebra of Γ . Since Γ is amenable and in $D(\mathbb{Z}_p)$, we have that the L^2 -dimension $\dim^{(2)} H_2(W_0; \mathcal{N}G)$ is not greater than the \mathbb{Z}_p -Betti number $b_2(W_0; \mathbb{Z}_p)$ by [2, Theorem 3.11]. It follows that $|\text{sign}_\Gamma^{(2)}(W_0)| \leq b_2(W_0; \mathbb{Z}_p)$. By Lemma 2.4(2), $b_2(W_0; \mathbb{Z}_p) = b_2(W_0)$. Since W_0 has positive definite intersection form, $b_2(W_0) = \text{sign}(W_0)$. It follows that $\rho^{(2)}(M(K), \phi) \leq 0$.

To prove the other conclusions of the theorem, consider the connected sum W of W_0 and r copies of $\mathbb{C}P^2$, where $r = b_2(V)$. Then W has the following properties:

- (1) $\partial(W) = M(K)$.
- (2) $H_1(W) \cong \mathbb{Z} \oplus$ (torsion coprime to p), and the meridian of K represents an integer coprime to p in $H_1(W)/\text{torsion} \cong \mathbb{Z}$.
- (3) $H_2(W) = \mathbb{Z}^{2r} \oplus$ (torsion coprime to p). There exist elements $\ell_1, \dots, \ell_r, d_1, \dots, d_r \in H_2(W; \mathbb{Z}[\pi_1(W)/\mathcal{P}^n \pi_1(W)])$ such that the images of the ℓ_i, d_j generate $H_2(W)$ modulo torsion, $\lambda_n(\ell_i, \ell_j) = 0$ and $\lambda_n(\ell_i, d_j) = \delta_{ij}$, where λ_n is the intersection pairing over $\mathbb{Z}[\pi_1(W)/\mathcal{P}^n \pi_1(W)]$.

(1) is obvious. (2) and the first statement of (3) follow immediately from Lemma 2.4. Consider the surfaces S_j given in Definition 2.3 of $\mathbb{Z}_{(p)}$ -homology n -positivity, and the surfaces $P_i = (\mathbb{C}P^1$ in the i^{th} $\mathbb{C}P^2$ summand). We may assume both S_j and P_i lie in W . Since $\pi_1(S_j), \pi_1(P_i) \subset \mathcal{P}^n \pi_1(W)$, the classes of S_j and P_i are in $H_2(\mathbb{Z}[\pi_1(W)/\mathcal{P}^n \pi_1(W)])$. We have $\lambda_n([S_i], [S_j]) = \delta_{ij}$, $\lambda_n([S_j], [P_i]) = 0$, and $\lambda_n([P_i], [P_j]) = -\delta_{ij}$. Therefore $\ell_i = [S_i] + [P_i]$ and $d_i = [S_i]$ satisfy (3).

If $\psi(\mathcal{P}^n \pi_1(V - \Delta)) = \{e\}$, then the proof of [2, Theorem 3.2] is carried out without any change, using (1), (2) and (3), to show $\rho^{(2)}(M(K), \phi) = 0$. \square

References

- [1] **A J Casson, CM Gordon**, *Cobordism of classical knots*, from: “À la recherche de la topologie perdue”, (L Guillou, A Marin, editors), Progr. Math. 62, Birkhäuser, Boston, MA (1986) 181–199 [MR900252](#)
- [2] **J C Cha**, *Amenable L^2 -theoretic methods and knot concordance* [arXiv:1010.1058](#)
To appear in Int. Math. Res. Not.
- [3] **J C Cha**, *The structure of the rational concordance group of knots*, Mem. Amer. Math. Soc. 189 (2007)
- [4] **J C Cha**, *Structure of the string link concordance group and Hirzebruch-type invariants*, Indiana Univ. Math. J. 58 (2009) 891–927 [MR2514393](#)

- [5] **J C Cha, T Kim**, *Covering link calculus and iterated Bing doubles*, *Geom. Topol.* 12 (2008) 2173–2201 [MR2431018](#)
- [6] **J C Cha, K H Ko**, *Signatures of links in rational homology spheres*, *Topology* 41 (2002) 1161–1182 [MR1923217](#)
- [7] **J C Cha, C Livingston, D Ruberman**, *Algebraic and Heegaard–Floer invariants of knots with slice Bing doubles*, *Math. Proc. Cambridge Philos. Soc.* 144 (2008) 403–410 [MR2405897](#)
- [8] **T D Cochran, S Harvey**, *Homology and derived p -series of groups*, *J. Lond. Math. Soc.* 78 (2008) 677–692 [MR2456898](#)
- [9] **T D Cochran, S Harvey, P Horn**, *Filtering smooth concordance classes of topologically slice knots*, *Geom. Topol.* 17 (2013) 2103–2162 [MR3109864](#)
- [10] **T D Cochran, P D Horn**, *Structure in the bipolar filtration of topologically slice knots* [arXiv:1208.5788](#)
- [11] **T D Cochran, W B R Lickorish**, *Unknotting information from 4-manifolds*, *Trans. Amer. Math. Soc.* 297 (1986) 125–142 [MR849471](#)
- [12] **T D Cochran, K E Orr, P Teichner**, *Knot concordance, Whitney towers and L^2 -signatures*, *Ann. of Math.* 157 (2003) 433–519 [MR1973052](#)
- [13] **N Habegger, X-S Lin**, *On link concordance and Milnor’s $\bar{\mu}$ invariants*, *Bull. London Math. Soc.* 30 (1998) 419–428 [MR1620841](#)
- [14] **M Hedden**, *Knot Floer homology of Whitehead doubles*, *Geom. Topol.* 11 (2007) 2277–2338 [MR2372849](#)
- [15] **M Hedden, P Kirk**, *Instantons, concordance, and Whitehead doubling*, *J. Differential Geom.* 91 (2012) 281–319 [MR2971290](#)
- [16] **M Hedden, C Livingston, D Ruberman**, *Topologically slice knots with nontrivial Alexander polynomial*, *Adv. Math.* 231 (2012) 913–939 [MR2955197](#)
- [17] **J Hom**, *The knot Floer complex and the smooth concordance group* [arXiv:1111.6635](#) To appear in *Comment. Math. Helv.*
- [18] **A S Levine**, *Slicing mixed Bing–Whitehead doubles*, *J. Topol.* 5 (2012) 713–726 [MR2971611](#)
- [19] **C Livingston, C A Van Cott**, *Concordance of Bing doubles and boundary genus*, *Math. Proc. Cambridge Philos. Soc.* 151 (2011) 459–470 [MR2838347](#)
- [20] **C Manolescu, B Owens**, *A concordance invariant from the Floer homology of double branched covers*, *Int. Math. Res. Not.* 2007 (2007) [MR2363303](#)
- [21] **P Ozsváth, Z Szabó**, *Absolutely graded Floer homologies and intersection forms for four-manifolds with boundary*, *Adv. Math.* 173 (2003) 179–261 [MR1957829](#)
- [22] **P Ozsváth, Z Szabó**, *Knot Floer homology and the four-ball genus*, *Geom. Topol.* 7 (2003) 615–639 [MR2026543](#)

- [23] **J A Rasmussen**, *Floer homology and knot complements*, Ph.D. thesis, Harvard University (2003) Available at <http://search.proquest.com/docview/305332635>
- [24] **C A Van Cott**, *An obstruction to slicing iterated Bing doubles*, *J. Knot Theory Ramifications* 22 (2013) [MR3070838](#)
- [25] **O J Viro**, *Branched coverings of manifolds with boundary, and invariants of links, I*, *Izv. Akad. Nauk SSSR Ser. Mat.* 37 (1973) 1241–1258 [MR0370605](#) In Russian; translated in *USSR Izv.* 7 (1973) 1239–1256

*Department of Mathematics, Pohang University of Science and Technology
Gyungbuk, Pohang 790-784, South Korea*

and

*School of Mathematics, Korea Institute for Advanced Study
Seoul 130–722, South Korea*

*Department of Mathematics, Indiana University
Rawles Hall, 831 East 3rd Street, Bloomington, IN 47405, USA*

jjccha@postech.ac.kr, macp@indiana.edu

Proposed: Peter Teichner

Seconded: Robion Kirby, Yasha Eliashberg

Received: 1 May 2013

Accepted: 7 October 2013

